

SACRAMENTO COUNTY WATER AGENCY

Master Water Study for the Florin Vineyard Community Plan

Sacramento County Water Agency

DRAFT

October 2006

**Reviewed and Edited by:
Robert Gardner, P.E.**

**Prepared by MWH:
Ping Chen, P.E.**

TABLE OF CONTENTS

SACRAMENTO COUNTY WATER AGENCY 1

SECTION 1. INTRODUCTION..... 1-1

 1.1 STUDY AREA..... 1-1

 1.2 PURPOSE AND OBJECTIVES 1-2

SECTION 2. BACKGROUND 2-1

 2.1 EXISTING GEOGRAPHICAL CONDITIONS2-1

 2.2 WATER PURVEYORS FOR THE FLORIN VINEYARD COMMUNITY PLAN2-1

 2.3 EXISTING WATER FACILITIES2-2

 2.4 PREVIOUS STUDIES2-2

SECTION 3. LAND USE AND WATER DEMAND PROJECTIONS 3-1

 3.1 PROPOSED LAND USES.....3-1

 3.2 WATER DEMAND ESTIMATES3-1

SECTION 4. WATER SYSTEM OPERATING GOALS..... 4-1

SECTION 5. WATER INFRASTRUCTURE REQUIREMENTS AND PHASING 5-1

 5.1 FACILITY REQUIREMENTS AND PHASING IN THE ZONE 40 WSIP 5-1

 5.2 DESCRIPTION OF WATER SUPPLY SOURCES AND PHASING 5-1

 5.3 WATER INFRASTRUCTURE REQUIREMENTS AND PHASING FOR THE STUDY AREA..... 5-7

SECTION 6. WATER DISTRIBUTION MODELING RESULTS 6-1

 6.1 MODELING SCENARIOS6-1

 6.2 MODELING ASSUMPTIONS6-1

 6.3 MODELING RESULTS6-2

SECTION 7. WATER FACILITY FINANCE SECTION..... 7-1

SECTION 8. NEXT STEPS 8-1

LIST OF FIGURES

FIGURE 1.	LOCATION OF FLORIN-VINEYARD COMMUNITY PLAN AREA	1-3
FIGURE 2.	PROPOSED LAND USE DIAGRAM FOR THE STUDY AREA (PLANNING DEPARTMENT ALTERNATIVE)	3-4
FIGURE 3.	THE RELATIONSHIPS BETWEEN VARIOUS FORMS OF WATER DEMANDS OF ZONE 40	3-5
FIGURE 4.	GRAPHIC ILLUSTRATION OF WATER SUPPLY SOURCES AND PHASING FOR THE STUDY AREA	5-3
FIGURE 5.	FVCP FACILITY REQUIREMENTS AND PHASING IN ZONE 40 WSIP	5-5
FIGURE 6.	WATER INFRASTRUCTURE REQUIREMENTS AND PHASING FOR THE STUDY AREA ^[1]	5-9
FIGURE 7.	ASSUMED MAX DAY DEMAND DIURNAL CURVE	6-2

LIST OF TABLES

TABLE 1.	PROPOSED LAND USES IN THE STUDY AREA AND CORRESPONDING LAND USE CLASSIFICATIONS IN ZONE 40 WSMP	3-2
TABLE 2.	LAND USE ACREAGE AND ANNUAL AVERAGE WATER DEMAND ESTIMATE FOR THE STUDY AREA	3-3
TABLE 3.	WATER DEMAND ESTIMATES FOR THE STUDY AREA WITHIN ZONE 40 [1]	3-5
TABLE 4.	ZONE 40 TRANSMISSION MAIN OPERATING GOALS	4-1
TABLE 5.	FIRE FLOW REQUIREMENTS FOR THE STUDY AREA	4-1
TABLE 6.	WATER SUPPLY SOURCES AND PHASING FOR THE STUDY AREA	5-2
TABLE 7.	WATER SUPPLY FACILITY AND PHASING REQUIREMENTS	5-8
TABLE 8.	MODELING RESULTS FOR MAX DAY DEMAND CONDITIONS FOR ALL WATER SUPPLY PHASES – 72 HOUR EPS RUN	6-3
TABLE 9.	MODELING RESULTS FOR FIRE FLOW CONDITIONS FOR ALL WATER SUPPLY PHASES	6-3
TABLE 10.	WATER SUPPLY FACILITY CAPITAL COSTS	7-1

LIST OF APPENDICES

APPENDIX A	DEMAND NODES AND PIPES IDS IN THE MODEL
APPENDIX B	MODELING RESULTS SCENARIO 1 – WATER SUPPLY PHASE 1
APPENDIX C	MODELING RESULTS SCENARIO 2 – WATER SUPPLY PHASE 2
APPENDIX D	MODELING RESULTS SCENARIO 3 – WATER SUPPLY PHASE 3
APPENDIX E	MODELING RESULTS SCENARIO 4 – WATER SUPPLY PHASE 4
APPENDIX F	MODELING RESULTS SCENARIO 5 – FIRE FLOWS

List of Acronyms

AAD – Annual Average Demand

ADD – Average Day Demand

Agency Act – Sacramento County Water Agency Act

Ag/res – agricultural/residential

AF – Acre Feet

Cal-Am – California-American Water Company

CEQA – California Environmental Quality Act

Central Basin – Central Sacramento County Groundwater Basin

CSA – Central Service Area

CVP – Central Valley Project

CVPIA – Central Valley Project Improvement Act

DEIR – Draft Environmental Impact Report

D-main – Smaller Water Distribution Main

DHS – Department of Health Services

EIR – Environmental Impact Report

FVCP – Florin Vineyard Community Plan

ISO – International Organization of Standardization

GMP – Groundwater Management Plan

MGD – Million Gallon per Day

MDD – Max Day Demand

NVSSP – North Vineyard Station Specific Plan

psi – pounds per square inch

PHD – Peak Hour Demand

SACOG – Sacramento Area Council of Governments

SCWA – Sacramento County Water Agency

VSCP – Vineyard Springs Comprehensive Plan

WFA – Water Forum Agreement

WSIP – Water System Infrastructure Plan

WSMP – Water Supply Master Plan

SECTION 1. INTRODUCTION

1.1 Study Area

The Florin Vineyard Community Plan (FVCP) is a 3,768-acre development area located within the communities of Florin, Vineyard and South Sacramento. The term “Florin Gap” has been referred to this area because it is located between the existing urban area west of Elk Grove-Florin Road and a comprehensively planned urban area to the east (i.e., North Vineyard Station Specific Plan or “NVSSP” and Vineyard Springs Comprehensive Plan or “VSCP”.) The area is bounded by Elder Creek Road and the Sacramento City limits to the north, Bradshaw Road excluding the NVSP area to the east, developed Churchill Downs and Vintage Park area to the south, and Elk Grove Florin Road and Union Pacific Railroad tracks to the west. The majority of the FVCP falls within the City of Sacramento’s (City) American River Place of Use (POU) boundary and within the SCWA Zone 40 boundary. Refer to **Figure 1** for the location of FVCP area and boundaries of the Study Area for this report. This is depicted in **Figure 1** as the shaded pink area with dot hatching and the small portion of the Florin County Water District (Florin County WD) that is shaded brown.

Zone 40 was created by Sacramento County Water Agency (SCWA) Resolution No. 663 in May 1985, which describes the exact boundaries of the zone, and defines the projects to be undertaken as “... the acquisition, construction, maintenance and operation of facilities for the production, conservation, transmittal, distribution and sale of ground or surface water or both for the present and future beneficial use of the lands or inhabitants within the zone.”

Through Zone 41, defined as the maintenance and operations branch of SCWA’s water supply service areas, SCWA will be the retail water purveyor for providing water supply for the portion of FVCP and NVSSP areas that fall within the SCWA Zone 40 boundary. The ultimate water supply source for the POU area will be the City’s American River POU water that is wholesaled to SCWA Zone 41 much like Zone 40 wholesales water to areas outside the American River POU. The source of the American River POU water is primarily through the City’s Fairbairn water treatment plant (WTP).

Before the POU water supply is introduced, interim water supplies for the FVCP (and NVSSP) area will come from offsite sources that either currently exist or are planned in accordance with the adopted 2005 Zone 40 Water Supply Master Plan (WSMP). All Zone 40 facilities are transferred to Zone 41 for operations and maintenance and for retail water service to Zone 41 customers. No new groundwater wells are proposed in the FVCP and NVSSP areas. The interim water supply sources include existing and future groundwater and surface water treatment plants in Zone 40. As these water supplies will be available in different phases at different locations, it is important to plan and phase the water distribution system for FVCP accordingly to deliver drinking water to the Study Area and the adjacent NVSSP areas throughout their development phasing while meeting SCWA's operating goals.

1.2 Purpose and Objectives

The primary objective of this study is to evaluate water supply demands, any large water distribution system requirements and phasing of large water facilities to accommodate development within the FVCP. This report, in part, satisfies the need to provide sufficient information on the water demands, water supplies, and water transmission system to assist the policy makers and SCWA in the review and approval of the FVCP Draft Environmental Impact Report (DEIR).

This report is not intended to satisfy SB 610 where the water retail provider is required to make a determination of water supply sufficiency. However, SCWA can use the information in this report for reference in the water supply sufficiency determination and in the identification of the needed water supply facilities.

Figure 1. Location of Florin-Vineyard Community Plan Area

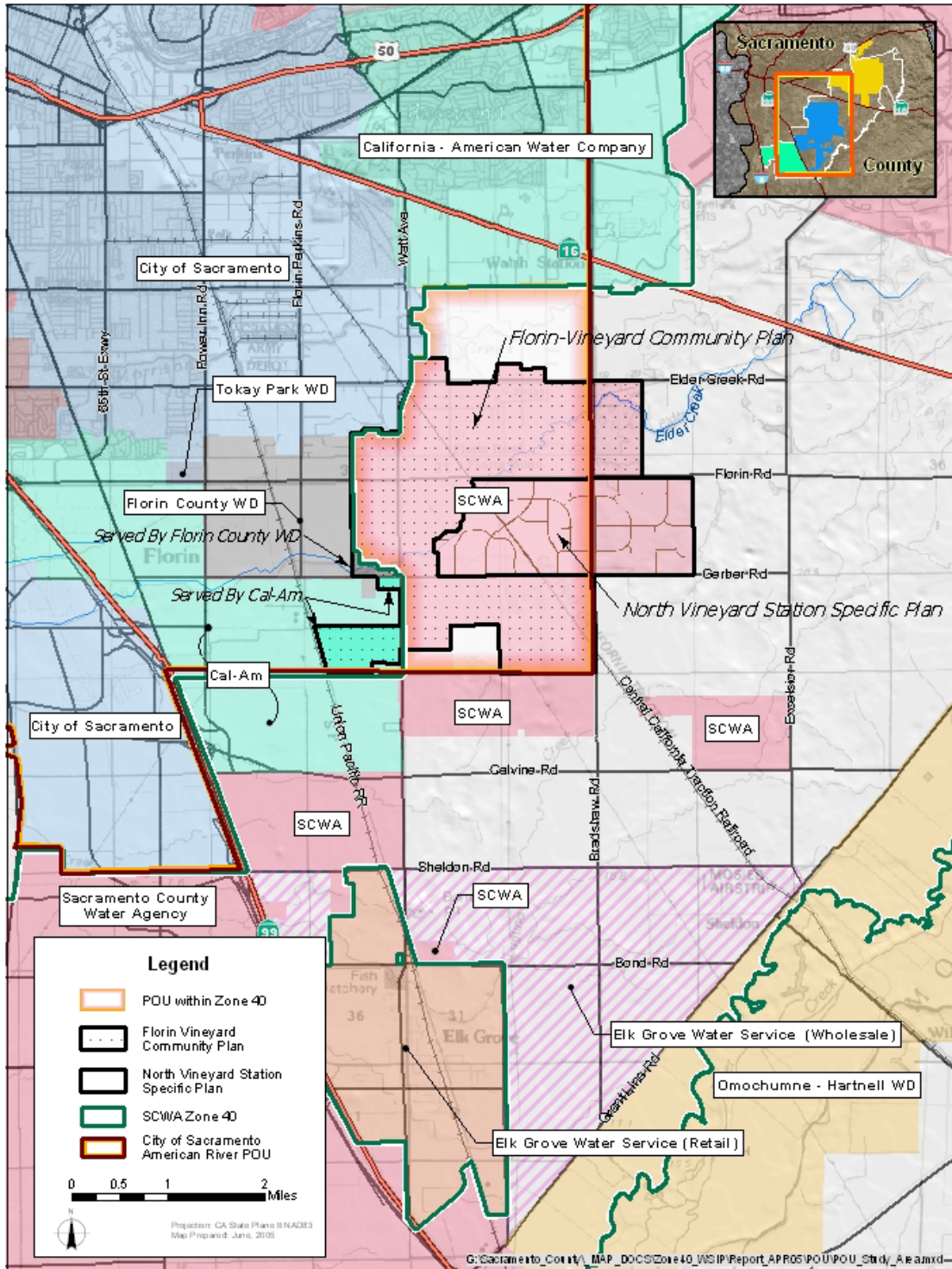

SECTION 2. BACKGROUND

This section describes the existing geographical conditions, existing water facilities, and previous studies completed for the Study Area.

2.1 Existing Geographical Conditions

The Study Area is fairly flat ranging in elevation from 40 feet to 60 feet above mean sea level. The overall area is largely undeveloped and has historically been used for agriculture, light industrial, and agricultural residential housing (small ranchettes). Elder Creek runs through the Study Area from northeast to southwest.

2.2 Water Purveyors for the Florin Vineyard Community Plan

Three water purveyors are identified to provide service to the FVCP: Zone 41 of SCWA, California American (Cal-Am) Water Company, and Florin County WD, see **Figure 1**.

(1) Zone 41

The operations and maintenance responsibilities for water supply facilities constructed by Zone 40 is by SCWA Zone 41, the retail water purveyor of the SCWA. All water supply infrastructure constructed by Zone 40 will be operated and maintained by Zone 41 to provide adequate quantities of water to its retail customers and to its wholesale customers (e.g., Elk Grove Water Service Company and to Cal-Am in the future development of the Security Park service area). Zone 41 also has service areas locate outside of Zone 40 where retail water service is provided. It is the goal of SCWA's Zone 40 to develop long-term water supplies including surface water and recycled water supplies to be used conjunctively with groundwater supplies. Sustainability of the groundwater resources underlying Zone 40 is a primary goal of Zone 41's utilization and operation of the various supply sources and related water facilities.

(2) California American Water Company

A portion of the FVCP (approximately 250 out of 3,768 acres) is located outside of the Zone 40 service boundary west of Elk Grove Florin Road and south of Gerber Road and within the Cal-

Am service area boundary. This study will mainly investigate the water supply and facility requirements to meet the water demand for the portion of the FVCP that lies within Zone 40. The demand for the portion of the FVCP within the Cal-Am service area is assumed to be met by Cal-Am.

(3) Florin County Water District

Another small fraction of the FVCP area outside of the Zone 40 service boundary near Gerber and Elk Grove-Florin Road is identified to be served by the Florin County WD. Given the size of the area within the Florin County WD, its water demand and supply analysis is also included in this study. This implies that the Zone 40 water system will be designed to serve this small area, but the decision of the which agency will be the retail water provider is not certain at this time. For example, one scenario may be that Zone 40 wholesales water to Florin County WD.

2.3 Existing Water Facilities

Currently, there are no municipal water supply and water distribution facilities located within the Study Area. Proposed water transmission and distribution facilities will be developed in accordance with SCWA's standards for water system improvements.

2.4 Previous Studies

Several previous reports and studies were reviewed in the preparation of this Study. These studies provide the framework and guidance for the water system design and planning in the Study Area. These studies include:

(1) The January 2000 Water Forum Agreement

Begun in 1993, the Sacramento Area Water Forum (Water Forum) is comprised of representatives from the business, environmental, public interest, and water purveyor communities. The co-equal objectives of the Water Forum are: 1) to provide reliable and safe water supply for the region's economic health and planned development through the year 2030, and 2) to preserve the fishery, wildlife, recreational, and aesthetic values of the lower American River. The Water Forum Agreement (WFA) prescribed a conjunctive use plan for Folsom Lake,

the lower American River, and the adjacent groundwater basins to achieve those goals. The Water Forum continues its role through the Water Forum Successor Effort and continuously monitors the progress in achieving the goals stated in the WFA.

(2) Zone 40 Water Supply Master Plan (SCWA, 2005)

In April 2005, SCWA approved the Zone 40 Water Supply Master Plan (WSMP) which updates the original 1987 Zone 40 Water Supply Master Plan and addresses changes made since the development of 1987 Master Plan. The most significant changes resulted from a major modification of the Central Valley Project's (CVP) contracting policy that occurred as a result of the Central Valley Project Improvement Act (CVPIA), the signing of the WFA, and the adoption of 1993 Sacramento County General Plan (General Plan) update that substantially increased the area designated for urban growth in the County.

The Zone 40 WSMP further defines SCWA's conjunctive use program of groundwater, surface water and recycled water supplies, as well as a financing program for the construction of surface water diversion and treatment facilities; water conveyance pipelines; groundwater extraction, treatment, storage, and distribution facilities; and recycled water storage and distribution facilities within Zone 40.

The Zone 40 WSMP also documents the unit water demand factors for various land use categories. These unit water demand factors along with the land use information will be used to estimate the water demand in the Study Area.

(3) Central Sacramento County Groundwater Management Plan (MWH, 2006)

The Central Sacramento County Groundwater Management Plan (GMP) sets forth objectives for managing the groundwater basin underlying the Central Sacramento County Basin of which Zone 40 overlies and establishes parameters for monitoring and reporting on the performance of the management strategies.

(4) Draft Zone 40 Water Systems Infrastructure Plan (MWH, 2006)

The purpose of the Zone 40 Water Systems Infrastructure Plan (WSIP) is to describe and quantify the facilities necessary to extract, treat, convey, and retail groundwater; store and pump City of Sacramento (City) American River Place of Use (POU) water; and treat and convey surface water at the future Vineyard Surface Water Treatment Plant (Vineyard SWTP). The WSIP is intended to be a planning document for SCWA staff and design engineers for Zone 40 facilities. For instance, significant design issues related to the interaction of facilities and events such as the construction of the Vineyard SWTP or development within the wholesale area of the City's POU will be investigated and detailed to show sizing and timing of facilities throughout Zone 40.

Unlike other planning documents where build-out facilities are typically viewed as the "project", the WSIP describes four phases of demand growth that represent significant milestones in water supply development within Zone 40 and reflect the anticipated pattern of development through build-out of the 2030 WSMP study area. These four phases represent existing conditions, first phase of the Vineyard SWTP (50 MGD), second phase of the Vineyard SWTP (expanding from 50 MGD to 100 MGD, the ultimate Vineyard SWTP's capacity), and build-out conditions. The WSIP also considers the range in operation of the various water supply facilities (i.e., groundwater and surface water) to account for wet and dry hydrologic conditions.

SECTION 3. LAND USE AND WATER DEMAND PROJECTIONS

Water demand evaluations based on land use information is considered to be the preferred method of determining water demands for a proposed project. Water demand forecasting using population and per capita demand factors is used only when land use information is not available. The benefit of land use-based water demand factors is that it allows for geographic location of the water demands in terms of computer modeling and setting up demand areas for the model. A land use water demand factor is determined by using actual meter data for each land use category, normalizing the data to what is considered to be a design condition (e.g., hydrologic year, level of water conservation and enforcement, etc.) and then associate each factor with the land use categories of the Study Area. This section describes the land uses and the associated water demand estimates for the Study Area.

3.1 Proposed Land Uses

Proposed land uses for the Study Area consist of a mix of residential, commercial, (light) industrial and open space designations. The land use diagram (the Planning Department Alternative) for the Study Area is shown in **Figure 2**. In order to use the unit demand factors adopted in the Zone 40 WSMP to calculate the water demands, the land use classifications for the Study Area are consolidated into the land use classifications identified in the Zone 40 WSMP, as shown in **Table 1**.

3.2 Water Demand Estimates

A water demand estimate determines the total quantity of water needed to serve the proposed development. **Table 2** summarizes the acreages for the consolidated land use classifications and the water demand estimates for the Study Area. The water demands are calculated separately for the areas within and outside of Zone 40.

The quantity of water demand is usually expressed in four forms: Average Annual Demand (AAD), Average Day Demand (ADD), Max Day Demand (MMD), and Peak Hour Demand (PHD). Each one of these forms of water demands serves a special purpose.

Average annual demand (AAD), often expressed as acre-feet per year (AF/year) provides very useful information for SCWA staff in developing their overall water supply for the Study Area. ADD, represented in million gallons per day (MGD), represents the average daily water demand for a water system. ADD is often evaluated in order to obtain MDD and PHD by applying a peaking factor. MDD is useful in determining the capacity of the conveyance pipeline to deliver groundwater/surface water (POU water) to the Study Area. PHD, often expressed in terms of gallons per minute (GPM) is used to size the water transmission and distribution pipelines, booster pumps, and on-site storage requirements to handle the PHD and ensure that service pressures are satisfied. Storage is a volume that is expressed in millions of gallons (MG).

The AAD is calculated first by applying unit water demand factors developed in the Zone 40 WSMP to the proposed land uses for the portion of the FVCP that lies within the Study Area. From there, the ADD, MDD, and PHD are obtained subsequently as shown in the **Figure 3**.

Table 3 shows the AAD, MMD, and PHD for the portion of Study Area located within Zone 40 including the small area served by the Florin County WD.

Table 1. Proposed Land Uses in the Study Area and Corresponding Land Use Classifications in Zone 40 WSMP

Land Use Classifications in the Land Use Diagram	Corresponding Land Use Classification in Zone WSMP	Area (Acres)	
		Within Zone 40 ^[1]	Outside of Zone 40
AR1	Rural Estates	32.9	
AR1-2	Rural Estates	247.1	
AR2-5	Rural Estates	132.8	
Subtotal		412.9	
RD2-3	Single Family	143.7	4.6
RD3-5	Single Family	910.8	189.4
RD5-7	Single Family	490.0	57.2
RD10	Single Family	13.6	
RD7-12	Single Family	65.2	
Subtotal		1,623.3	251.2
RD20	Multi Family - High Density	128.4	
Subtotal		128.4	
BP	Commercial	4.7	
GC	Commercial	10.2	
SC	Commercial	107.2	
LC	Commercial	18.5	
Subtotal		140.5	
IR	Light Industrial	233.7	
M1	Light Industrial	882.0	
Subtotal		1,115.7	
OS	Open Space	95.9	
Subtotal		95.9	
TOTAL		3,516.7	251.2

Table 2. Land Use Acreage and Annual Average Water Demand Estimate for the Study Area

Land Use ^[1]	Unit Demand Factors (AF/Ac/Yr) ^[2]	Area (Acres)			Annual Average Water Demand (AF/Year)		
		Within Zone 40 ^[3]	Outside of Zone 40 ^[4]	Total	Within Zone 40	Outside of Zone 40	Total
Rural Estates	1.33	412.9	-	412.9	549.1	-	549.1
Single Family	2.89	1,623.3	251.2	1,874.5	4,691.5	726.0	5,417.4
Multi-Family	4.12	128.4	-	128.4	528.9	-	528.9
Commercial	2.75	140.5	-	140.5	386.4	-	386.4
Light Industrial	1.36 ^[5]	1,115.7	-	1,115.7	1,511.7	-	1,511.7
Open Space	0	95.9	-	95.9	-	-	-
Subtotal (w/o system loss)					7,667.7	726.0	8,393.7
Water System Loss (7.5%)					575.08	54.45	629.53
Total Land and Demand		3,516.7	251.2	3,767.9	8,243	780	9,023

Notes:

- [1] The land use classifications for the FVCP are consolidated into land use classifications in the Zone 40 WSMP.
- [2] Use the unit water demand factors in the Zone 40 WSMP.
- [3] Include the small area served by Florin County WD.
- [4] Cal-Am and Florin County W D are identified as the water purveyors for the FVCP outside Zone 40 south of Gerber Road and west of Elk Grove-Florin Road.
- [5] In the Zone 40 Water Supply Master Plan (Feb 2005), 2.71 AF/Ac/Yr is identified as the unit water demand factor for "Industrial", 0 AF/Ac/Yr for "Industrial - Unutilized". The WSMP does not specify the unit demand factor for "Light Industrial", so it is assumed to be 50% of that of "Industrial".

Figure 2. Proposed Land Use Diagram for the Study Area (Planning Department Alternative)

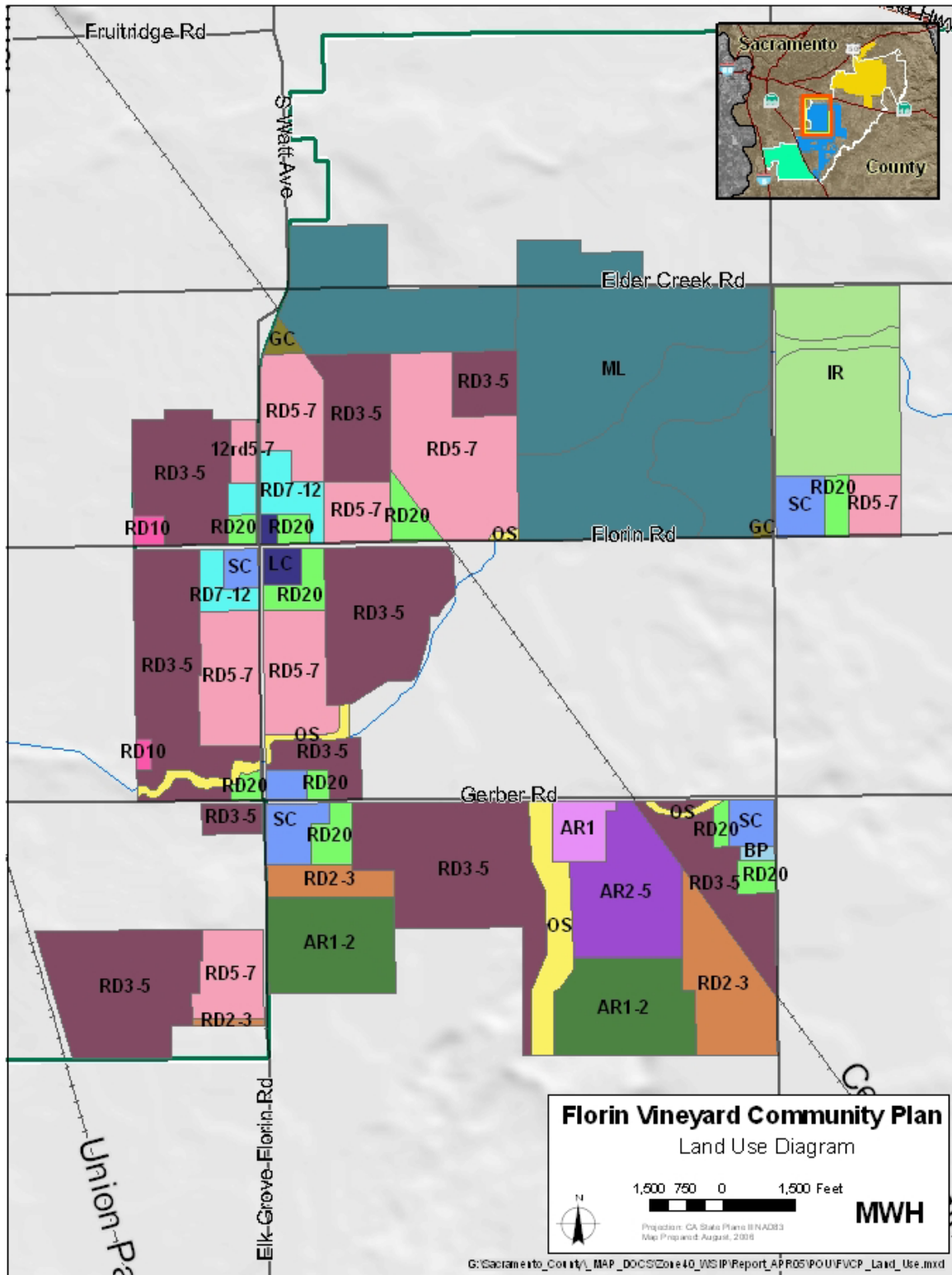

Figure 3. The Relationships Between Various Forms of Water Demands of Zone 40

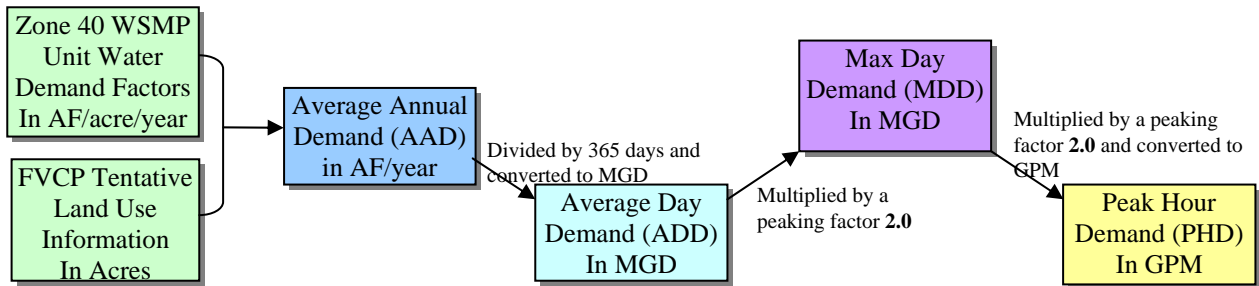

Table 3. Water Demand Estimates for the Study Area within Zone 40 [1]

Average Annual Demand (AF/year)	Average Day Demand (MGD)	Max Day Demand (MGD)	Peak Hour Demand (gpm)
8,243	7.36	14.72	20,436

Note:

[1] Demands include 7.5% system loss.

SECTION 4. WATER SYSTEM OPERATING GOALS

This section describes SCWA’s operating goals in the design of transmission main (T-main) pipelines within Zone 40. These T-main operating goals were established to ensure that adequate pressures are maintained under normal and fire flow operating conditions, and to maintain T-main flow velocities within an acceptable operating range. These T-main operating goals are included in **Table 4**.

Table 4. Zone 40 Transmission Main Operating Goals

CONDITION	OPERATING GOALS
Normal System Operation Condition	
Minimum pressure	40 psi
Maximum pressure	75 psi
Maximum Velocity	5 fps
Maximum head loss per 1,000 lf	5 ft ^[1]
Fire Flow Condition	
Minimum residual pressure at fire hydrant	20 psi

Note:

[1] This goal should be used as a general guideline for the system. Maintaining the minimum residual system pressure should be the controlling design criteria.

The water distribution system must be sized to provide adequate fire flows at minimum residual pressures specified by the International Organization of Standardization (ISO) and local fire departments. The Study Area is located in the service area of the Sacramento Metropolitan Fire District. The fire flow requirements used for the Study Area are shown in **Table 5**.

Table 5. Fire Flow Requirements for the Study Area

LAND USE	Fire Flow Requirement (gpm)	Minimum Residual Pressure (psi)	Duration (Hours)
Residential			
Homes up to 3,600 sq. ft.	1,500	20	2
Homes up to 4,800 sq. ft.	1,750	20	2
Homes up to 6,200 sq. ft.	2,000	20	2
Commercial	3,000	20	3
Industrial	4,000	20	4

SECTION 5. WATER INFRASTRUCTURE REQUIREMENTS AND PHASING

As any new development project proceeds in the land use entitlement and construction process, the water supply availability and method of providing water service to the project may change over time. This section best describes the water infrastructure requirements and phasing to meet the water demands in the build-out and interim conditions based on the most current information and understandings of how, when and where potable water will come from to serve the Study Area.

5.1 Facility Requirements and Phasing in the Zone 40 WSIP

The Zone 40 WSIP provides the framework for water facility requirements for the entire Zone 40 wholesale service area including the Study Area. The facility phasing in the Zone 40 WSIP is defined corresponding to the two proposed phases of the Vineyard SWTP. The first phase of the Vineyard SWTP (50 MGD) is currently under design and anticipated to come online in year 2011. The second phase of the Vineyard SWTP (add another 50 MGD to reach the full 100 MGD build-out treatment capacity) is estimated to be constructed near 2022. **Figure 4** shows the facility requirements for the build-out condition and the phasing according to the construction phases of the Vineyard SWTP in the Zone 40 WSIP for the Study Area. Given the fast projected growth in the FVCP area in the near future, additional interim phase conditions need to be considered within the Zone 40 WSIP framework to provide the sequence of facility construction to provide SCWA staff with proper sequencing of water facilities that will lead them to ultimate build-out conditions while ensuring reliable water supplies for the Study Area.

5.2 Description of Water Supply Sources and Phasing

The water supply sources and phasing for the Study Area are summarized in **Table 6** and graphically shown in **Figure 4**. The water supply phasing described in this document does not specify which year each water supply phasing could actually start because that the water supply phasing is essentially water demand driven rather than time-driven depending on the growth rate. The SACOG's population growth projection is used to estimate the projected increase in water

demand in the Study Area, as it was used to estimate the water demand for the region in the Zone 40 WSIP.

Table 6. Water Supply Sources and Phasing for the Study Area

Water Supply Sources	FVCP Water Supply Phases			
	Phase 1	Phase 2	Phase 3	Phase 4 (Build Out)
	Capable of providing up to 4,040 AF/Year to the Study Area	Capable of providing up to 7,670 AF/Year to the Study Area	Capable of providing up to build-out demand to the Study Area (8,240 AF/Year) until the growth in Zone 40 necessitates the ultimate POU Water supply	Capable of providing up to build-out demand to the Study Area (8,240 AF/Year)
Waterman GWTP	X	X	O	O
Wildhawk GWTP	X	X	O	O
Initial Connection to the City's Water System		X	O	O
First phase of Vineyard WTP			X	O
American River POU Water				X

Notes:

X – Primary Water Supply Source(s)

O – Secondary/Backup Water Supply Source(s)

(1) Water Supply Sources – Phase 1

The first phase of water supplies will come from groundwater. Currently, there are two off-site groundwater treatment plants (GWTPs) in the vicinity of the Study Area: The Waterman GWTP and the Wildhawk GWTP, see **Figure 5**.

Figure 4. Graphic Illustration of Water Supply Sources and Phasing for the Study Area

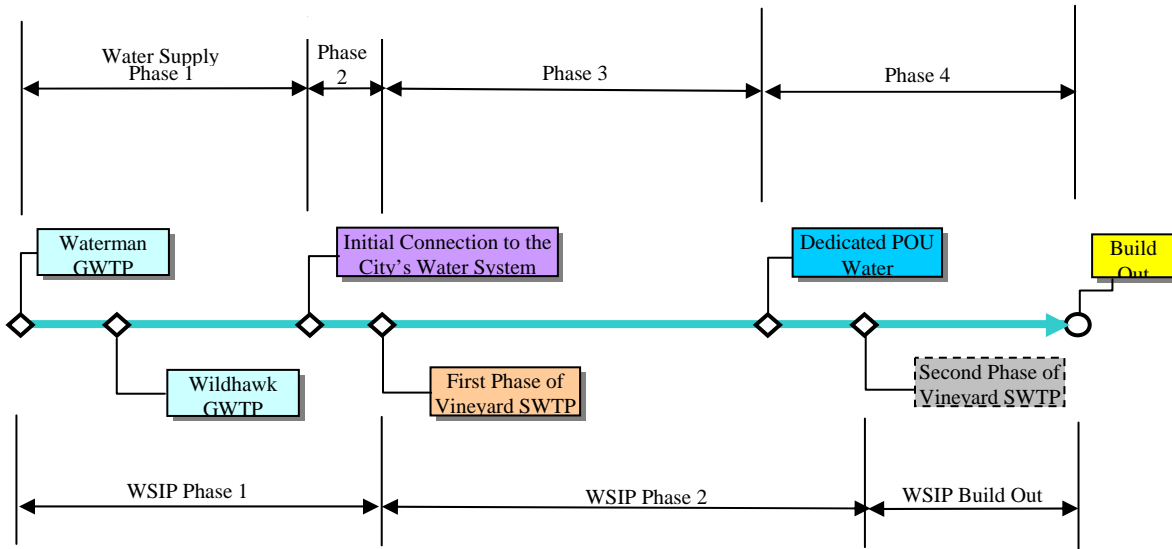

The Waterman GWTP has a treatment capacity of 8.6 MGD located south of the Study Area at Waterman Road north of Calvine Road currently serving the Vineyard and Vintage Park service areas. The Waterman GWTP can provide a limited amount of water for the initial development in the Study Area and the NVSSP via the existing 24-inch diameter T-main in Elk Grove-Florin Road that runs north and is currently terminated at the intersection of Gerber Road.

The Wildhawk GWTP has an ultimate treatment capacity of 10 MGD and is located east of Vineyard Road and south of Gerber Road and is anticipated to be operational in the fall of 2006. The Wildhawk GWTP will be the major near-term water supply source for new development in the Study Area and the NVSSP area. A T-main will be constructed in Gerber Road from the intersection with Vineyard Road to NVSSP that will also connect to the existing 24-inch diameter T-main in Elk Grove-Florin Road mentioned above creating a looped system.

(2) Water Supply Sources – Phase 2

The Phase 2 water supplies involves the development of an initial POU connection to the City’s water system at Elder Creek Road and South Watt Avenue to supplement the Waterman and Wildhawk GWTPs’ water supply before Phase 1 of the Vineyard SWTP becomes operational.

This City connection can serve as a back up supply after Phase 1 of the Vineyard SWTP and once the dedicated POU water facilities are constructed and become operational. The capacity of the initial POU connection is determined by a number of factors including the demand growth in the Study Area and NVSSP area, the wheeling ability of the City's water distribution system, and the timing of the Vineyard SWTP. It is preliminarily estimated that up to 4,500 gpm of flow capacity will be needed at this interim connection.

Figure 5. FVCP Facility Requirements and Phasing in Zone 40 WSIP

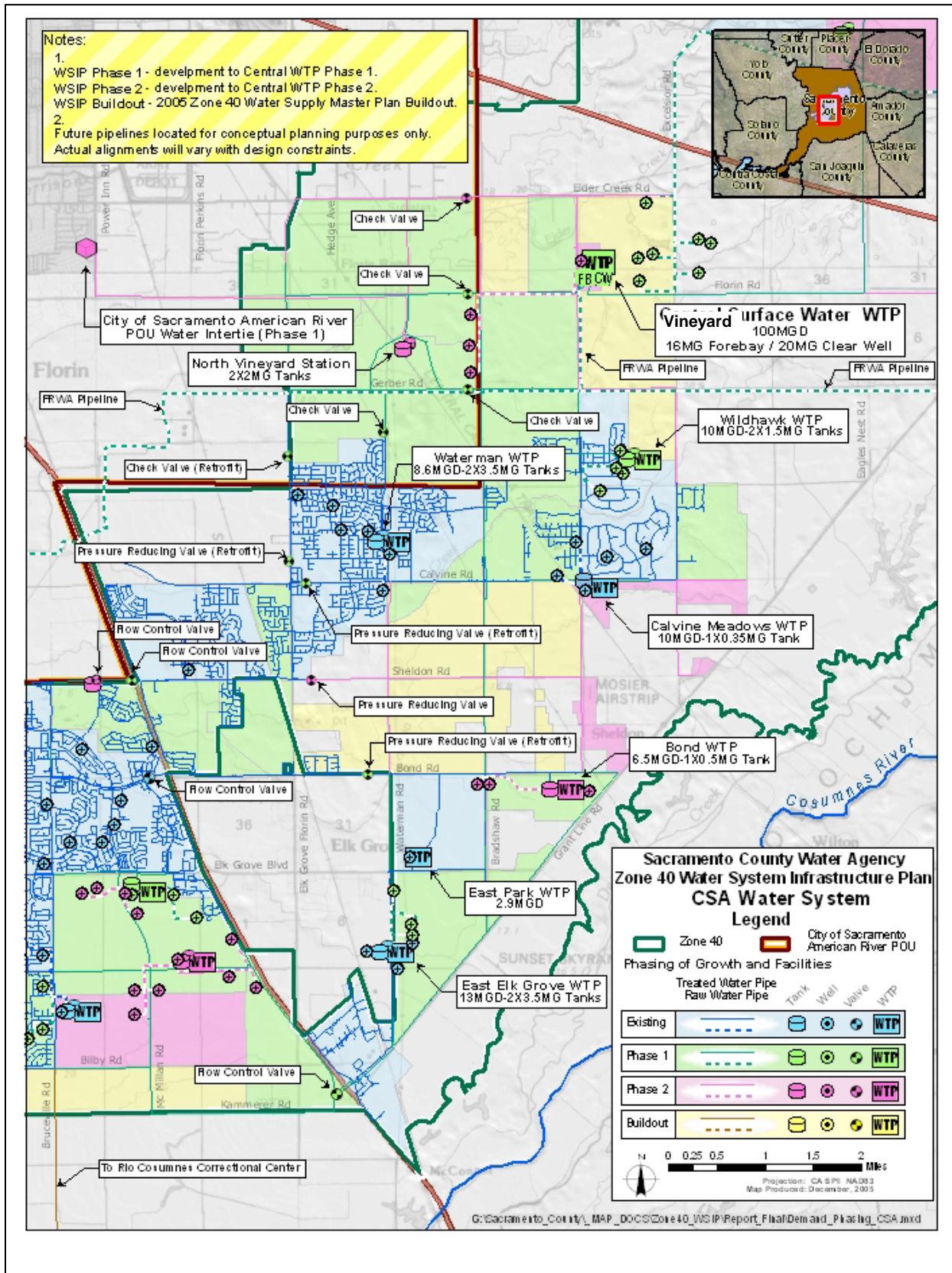

(3) Water Supply Sources – Phase 3

Completion of Phase 1 of the Vineyard SWTP (50 MGD) is identified as the primary water supply source in Development Phase 3 for the Study Area. The treated water from the Vineyard SWTP will be used in Zone 40 in conjunction with groundwater. The Vineyard SWTP is identified as a critical water supply element in the Zone 40 WSMP and WSIP to implement Zone 40's conjunctive use objectives. The objective is to maximize the use of surface water in wet and normal years and allow the groundwater basin to recharge naturally to allow for sufficient groundwater availability in dry years when surface water cutbacks will occur.

The Vineyard SWTP is proposed as the primary water supply source for the Study Area under Phase 3 conditions, while Waterman and Wildhawk GWTPs will serve as supplemental water sources (i.e. dry years and under emergency conditions). As development continues in Zone 40, the capacity of the Vineyard SWTP will reach its maximum and will necessitate the next phase in the SWTP and in the construction of additional groundwater supply sources.

(4) Water Supply Source(s) – Phase 4 (Build Out)

The ultimate water supply for the portion of the Study Area within both Zone 40 and the City of Sacramento's American River POU is the City's treated surface water diverted from the American River at the Fairbairn SWTP, or referred herein as the "POU water". The majority of the Study Area, along with the portion of the NVSSP area west of Bradshaw Road, is located within the City's American River Water POU area. The POU water will be wholesaled to SCWA based on a wholesale water agreement(s) between SCWA and the City that is currently being negotiated¹.

The reliability of the POU water is rated "high" in the Zone 40 WSMP and the POU water will be the single water supply source once the POU water delivery is considered to be dedicated capacity from City water facilities that will be met through City water rights and system operations. The maximum amount of POU water delivery is determined by the build-out water

¹ An existing wholesale wheeling agreement currently exists for Zone 50 of the SCWA that is being amended to include all wholesale connections with the City.

demand in the POU area within Zone 40 estimated to be 10,644 AF/Year including 7.5% system losses.

For the small portion of the Study Area outside of the POU area, the Vineyard SWTP in combination with the Waterman and Wildhawk GWTPs will be the water supply sources.

5.3 Water Infrastructure Requirements and Phasing for the Study Area

This section describes the facility requirements based on the proposed development phases for the Study Area and the water supply phases described in the previous section. This section, especially **Figure 6** and **Table 7**, will be used by SCWA staff to identify the necessary infrastructure and when certain facilities must be constructed to provide a reliable water supply to the Study Area.

Table 7. Water Supply Facility and Phasing Requirements

PHASE	Water Supply Sources	SUB-PHASE	FACILITY REQUIREMENTS	DESCRIPTION
PHASE 1	Waterman and Wildhawk GWTP's	1-A	(i) 24" T-main in Gerber Road from Elk Grove-Florin Road to Vineyard Road	Introduce treated water from Waterman and Wildhawk GWTPs to the initial development in NVSSP, and later to the Study Area.
			(ii) 24" and 30" T-mains from Wildhawk GWTP to Gerber Road	Connect Wildhawk GWTP with the Gerber Road T-main.
			(iii) 18" T-main in the NVSSP area	Deliver water to the initial development area in the NVSSP.
		1-B	24" and 36" T-mains between Gerber and Florin Roads, and 24" in Florin Road in west NVSSP area	Introduce treated water from Waterman and Wildhawk GWTPs to the Study Area through the NVSSP area.
			1-C	(i) 16" T-main in Elk Grove-Florin Road and 24" T-main in Florin Roads
		(ii) 48" T-main in Bradshaw Road between Florin and Gerber Roads		Serve the NVSSP area along Bradshaw Road. The T-main is also part of the "backbone" transmission line to deliver the treated water from the Vineyard WTP to the Zone 40 CSA ^[1] in the future.
PHASE 2	Waterman and Wildhawk GWTP's and Interim Connection to the City	-	(i) 24" T-main in Elder Creek Road from S. Watt Ave. to Florin Perkins Road.	Connect to the City's water distribution system to provide interim POU water supply to the Study area
			(ii) Inline booster pump station in Elder Creek Road west of S. Watt Ave.	Maintain sufficient system head when connected to the City's water distribution system.
			(iii) 16" and 24" T-mains in Tokay Ln	Connect the City's intertie to the FVCP water distribution system.
			(iv) 16" T-main in Waterman south of Gerber Road	Deliver treated water to the development area south of Gerber Road
PHASE 3	First Phase of Vineyard WTP	-	(i) First phase of the Vineyard WTP (50 MGD)	Treat surface water diverted from the Sacramento River through Freeport Diversion facility and FRWA transmission pipeline
			(ii) 60" T-main in Florin Road from the Vineyard WTP to Bradshaw Road	Connect the Vineyard WTP to the FVCP and NVSSP water distribution system. The T-main is also part of the "backbone" transmission line to deliver the treated water from the Vineyard WTP to the Zone 40 CSA ^[1] in the future.
			(iii) 48" T-main in Bradshaw Road south of Gerber Road	Serve the FVCP area south of Gerber Road and along Bradshaw Road. The T-main is also part of the "backbone" transmission line to deliver the treated water from the Vineyard WTP to the Zone 40 CSA ^[1] in the future.
PHASE 4	POU Water	-	(i) 36" POU water transmission pipeline from Florin reservoir near Power Inn Road to the NVS storage tanks in the NVSSP area	Dedicated low-head transmission line conveying the full amount of the POU water from the City's system to the POU area within Zone 40.
			(ii) Two 2-MG NVS storage tanks and pump station	Store and distribute POU water to the POU area
			(iii) 16" and 24" T-mains in Florin, Bradshaw, and Vineyard Roads	Serve the last phase of the development areas in the FVCP and NVSSP areas.
			(iv) Check valves on the POU area boundaries	Isolate POU area from the rest of the Zone 40 area to ensure that the POU water is used in the POU area.

Note: [1] CSA means the Central Service Area of Zone 40. The Zone 40 service area is geographically divided into three sub-service areas in the Zone 40 WSIP: North Service Area (NSA), Central Service Area (CSA), and South Service Area (SSA). NSA refers to the portion of Zone 40 service area north of HWY 16 (Jackson Highway) including the Sunrise Douglas Community Plan and Rio del Oro development areas. CSA refers to the portion of Zone 40 service area between HWY 99 and HWY 16. SSA refers to the portion of Zone 40 service area west of HWY 99 and north of Kammerer Road.

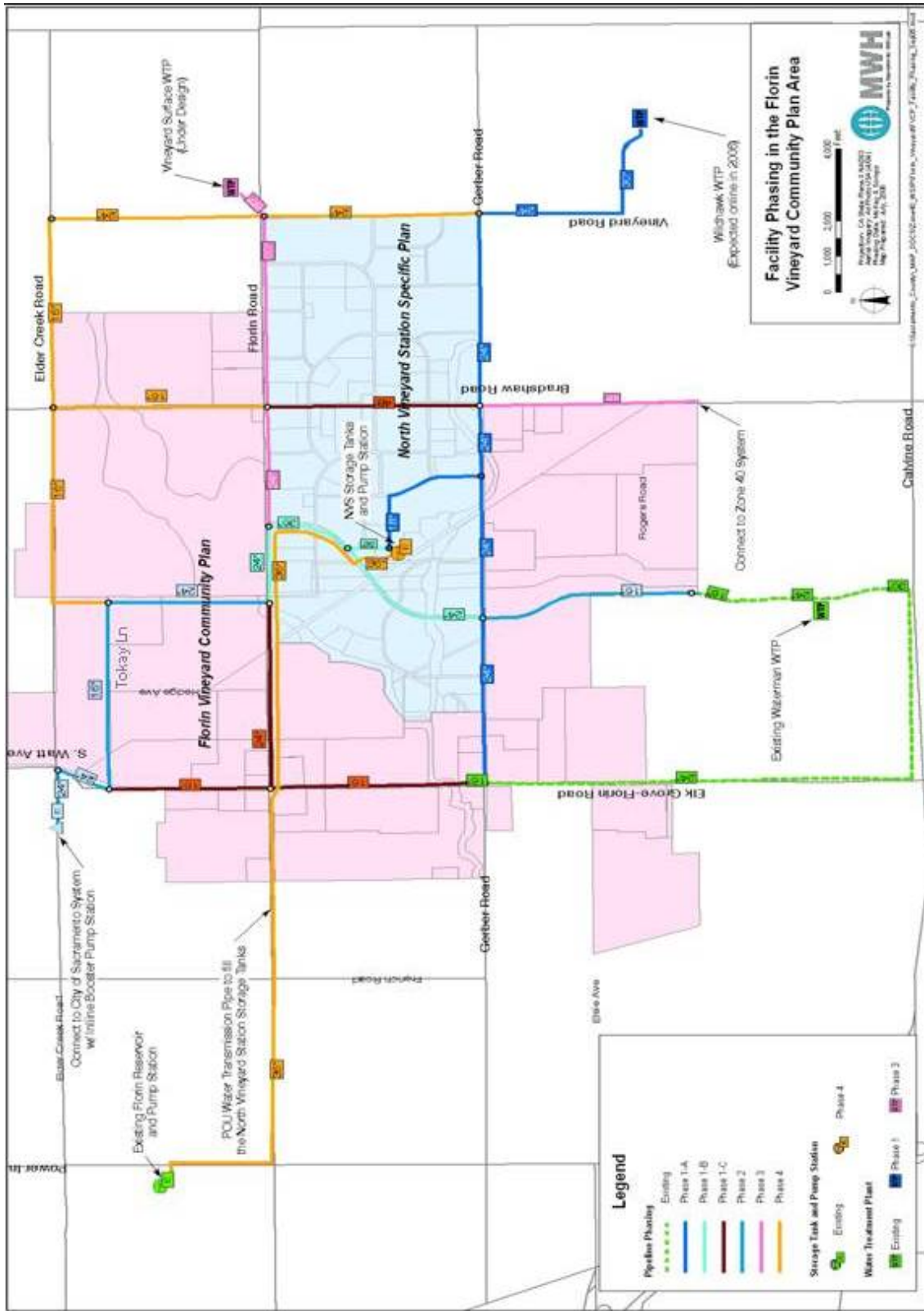

Note: [1] The facility phasing is corresponding to the water supply phasing for the Study Area described in the previous section.

Figure 6. Water Infrastructure Requirements and Phasing for the Study Area [1]

SECTION 6. WATER DISTRIBUTION MODELING RESULTS

The water distribution modeling was conducted for a number of scenarios to verify that the SCWA operating goals are met in the proposed water distribution system in the Study Area. The water distribution modeling in this study uses the regional water distribution model developed for the Zone 40 WSIP.

6.1 Modeling Scenarios

The modeling scenarios evaluated in this study include:

Scenario 1 – Evaluate the proposed water distribution system for water supply Phase 1.

Scenario 2 – Evaluate the proposed water distribution system for water supply Phase 2.

Scenario 3 – Evaluate the proposed water distribution system for water supply Phase 3.

Scenario 4 (Build-out) – Evaluate the proposed water distribution system for water supply Phase 4.

Fire Flows – Evaluate the fire flow capacities of the proposed water distribution system at all water supply phases.

6.2 Modeling Assumptions

The following are assumptions used in the water distribution model:

- A Hazen William’s “C” factor of 130 was used for new pipes and 125 used for existing pipes.
- A 72-hour Extend Period Simulation (EPS) was used to represent the system operations under various demands. The assumed Max Day Demand diurnal curve is shown in **Figure 7**, which is also used in the Zone 40 WSIP study.
- A Max Day Demand condition was assumed for each modeling scenario.
- The sizes of T-main and other major facilities were determined from the Zone 40 WSIP regional model.

- Assume the maximum capacity at the interim connection to the City at South Watt Ave. and Elder Creek Road is 4,500 gpm.

Figure 7. Assumed Max Day Demand Diurnal Curve

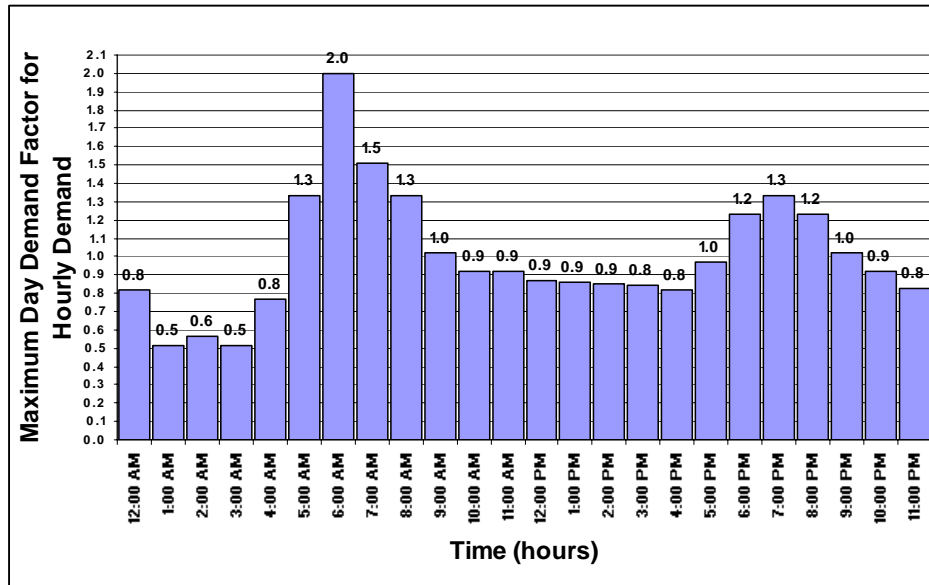

6.3 Modeling Results

This section presents the modeling results for all the modeling scenarios described previously. The modeling results for operating conditions in Maximum Day conditions for scenarios 1 thru 4 are shown in **Table 8**, and Fire Flows in **Table 9**. More detailed modeling results are included in **Appendices B** through **F** with reference to the demand nodes and pipes identifications shown in **Appendix A**.

The modeling results indicate that the proposed water supplies and the proposed T-main network are able to meet the demand growth in the Study Area and also satisfy the SCWA’s operating goals.

Table 8. Modeling Results for Max Day Demand Conditions for All Water Supply Phases – 72 Hour EPS Run

	Minimum	Average	Maximum ^[1]
Scenario 1 - Water Supply Phase 1			
Demand (gpm)	894	1,752	3,504
Pressure (psi)	69.3	73.9	78.5
Velocity (ft/s)	0	-	3.0
Scenario 2 - Water Supply Phase 2			
Demand (gpm)	3,703	7,260	14,520
Pressure (psi)	51.1	64.4	77.6
Velocity (ft/s)	0	-	4.3
Scenario 3 - Water Supply Phase 3			
Demand (gpm)	3,703	7,260	14,520
Pressure (psi)	47.7	62.8	78.2
Velocity (ft/s)	0	-	5.1
Scenario 4 - Water Supply Phase 4			
Demand (gpm)	5,109	10,218	20,436
Pressure (psi)	48.1	65.5	82.9
Velocity (ft/s)	0	-	5.8

Note: [1] Refers to the maximum values for demand, pressure, and velocity over 72 hours. Those maximum values do not necessarily occur at the same time. Some maximum pressure values are shown slightly greater than the maximum operating goal and can be considered acceptable as they usually occur in midnight when the demand is lowest.

Table 9. Modeling Results for Fire Flow Conditions for All Water Supply Phases

	Fire Flow Duration (Hours)	Minimum Residual Pressure (psi)
Fire Flow for Water Supply Phase 1		
2,000 gpm Fire Flows for Residential	2	70
3,000 gpm Fire Flows for Commercial	3	73
Fire Flow for Water Supply Phase 2		
2,000 gpm Fire Flows for Residential	2	66
3,000 gpm Fire Flows for Commercial	3	65
Fire Flow for Water Supply Phase 3		
2,000 gpm Fire Flows for Residential	2	61
3,000 gpm Fire Flows for Commercial	3	67
Fire Flow Water Supply Phase 4		
2,000 gpm Fire Flows for Residential	2	56
3,000 gpm Fire Flows for Commercial	3	65

SECTION 7. WATER FACILITY FINANCE SECTION

The purpose of this section is to provide, at a planning level, the estimated cost for construction of the necessary water supply facilities by Zone 40. The Zone 40 Development Fee and User Fee programs (Zone 40 Fee Program) will be used to finance the facilities identified in this study including the capital buy-in to obtain service from the City of Sacramento. Zone 41 user rates will be used to purchase treated surface water from the City of Sacramento within the POU area.

Table 10. Water Supply Facility Capital Costs

Water Supply Facilities	Total Units	Unit Cost	Cost
Water Supply Phase 1	(FT)	(\$/LF)	(\$)
16" Pipeline	8,902	\$140	\$1,246,340
18" Pipeline	3,869	\$158	\$611,282
24" Pipeline	31,004	\$210	\$6,510,860
30" Pipeline	2,370	\$263	\$623,423
36" Pipeline	3,647	\$315	\$1,148,800
48" Pipeline	5,260	\$420	\$2,209,209
Subtotal	55,053	-	\$12,349,914
Water Supply Phase 2	(FT)	(\$/LF)	(\$)
16" Pipeline	11,902	\$140	\$1,666,225
24" Pipeline	28,529	\$210	\$5,991,086
Inline Booster Pump	(HP) 170.6	(\$/HP) \$1500	\$255,900
Subtotal	-	-	\$7,913,210
Water Supply Phase 3	(FT)	(\$/LF)	(\$)
24" Pipeline	3,324	\$210	\$697,952
48" Pipeline	5,380	\$420	\$2,259,395
60" Pipeline	6,166	\$525	\$3,237,212
Subtotal	-	-	\$6,194,559
Water Supply Phase 4			
Capital Buy-in for City of Sacramento POU Water	(FT)	(\$/LF)	(\$)
36" POU Pipeline	22,630	\$315	\$7,128,450
Hanfield (North Vineyard Station) Storage Tanks	(MG) 4	(\$/MG) \$300,000	(\$) \$1,200,000
	(HP) 1,026	(\$/HP) \$1,500	(\$) \$1,539,000
Subtotal	-	-	\$9,867,450
TOTAL	-	-	\$36,325,134

The Zone 40 Fee Program accounts for all aspects of providing water service to the entire Zone 40 area including the Study Area. Upon completion of this study, the Zone 40 WSIP will be updated to reflect any changes as a result of this study, and the Zone 40 Fee Program will be adjusted, if needed, to accommodate the necessary water supply facilities identified in **Table 10**.

For a more comprehensive discussion on the Zone 40 Fee Program, the reader is advised to review the Zone 40 WSMP and WSIP where the overall Capital Improvement Program and the necessary fees are identified. In addition, the WSIP provides a detailed description of the type of facilities constructed by SCWA and the type that are constructed by the developer and reimbursed through credits and reimbursement agreements. The developer is solely responsible for the distribution mains that are said to benefit the individual projects.

SECTION 8. NEXT STEPS

The primary objective of this study was to evaluate the water supply and large water distribution system requirements and facilities phasing for the portion of the Study Area located within Zone 40 (including a small portion located with Florin County WD). Upon approval of the FVCP by the Sacramento County Board of Supervisors, individual development applications will be requested (or conditioned) to prepare a supplemental water supply study that complements this report in terms of identifying the needed lands and rights-of-way for the facilities identified in this report, and to size the local distribution mains, not included in this report, that will serve individual homes.

APPENDIX A

Demand Nodes and Pipes IDs in the Model

Figure A-1. Nodes and Pipes ID's in the Model

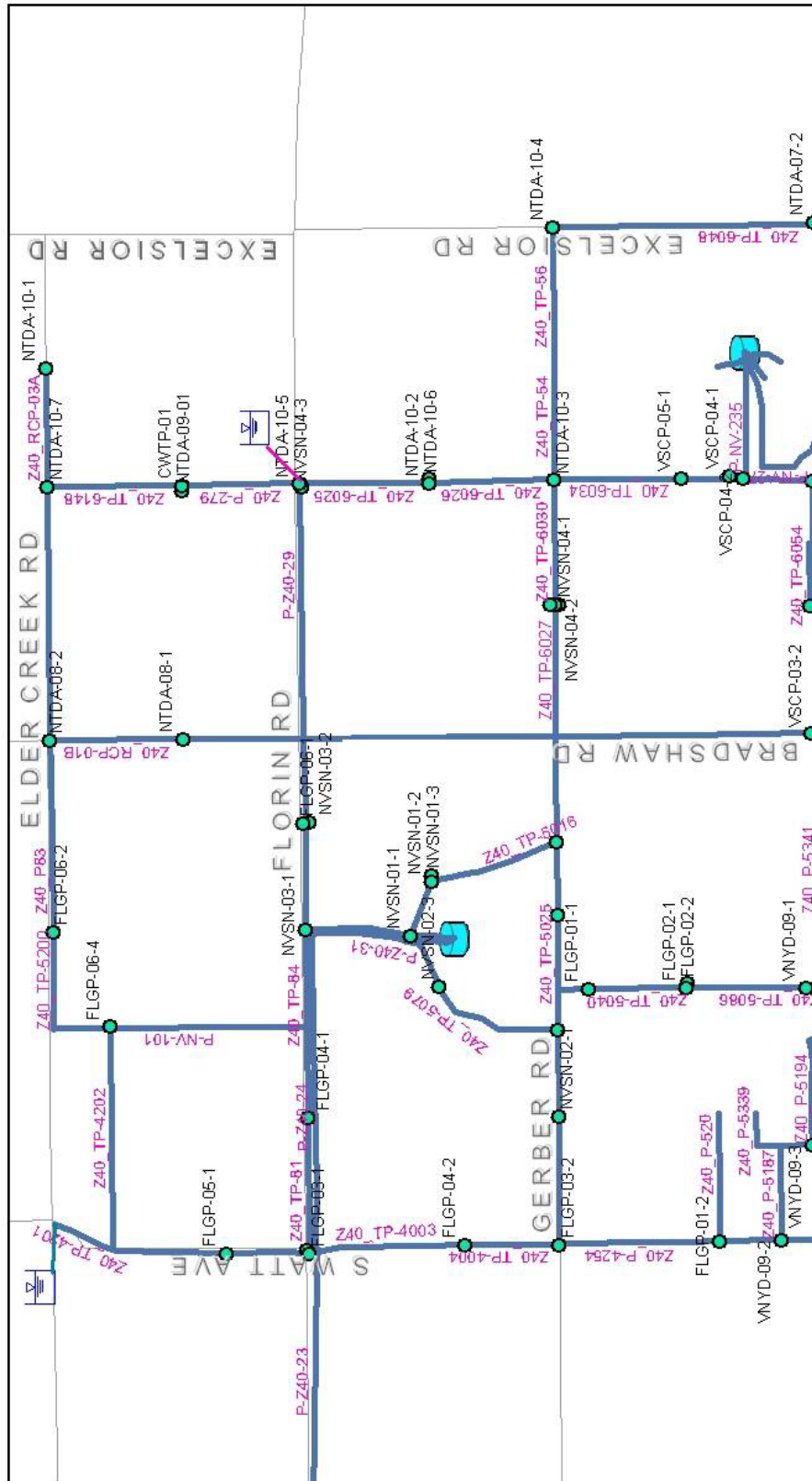

APPENDIX B

Modeling Results Scenario 1 – Water Supply Phase 1

Table B-1. Node Demand Ranges for Max Day Conditions – Water Supply Phase 1

ID	Max.Value (gpm)	Max.Time (hrs)	Min.Value (gpm)	Min.Time (hrs)	Average (gpm)	Difference (gpm)
FLGP-04-1	438.4	6:00	111.8	1:00	218.4	326.6
FLGP-03-1	438.4	6:00	111.8	1:00	218.4	326.6
FLGP-06-3	438.4	6:00	111.8	1:00	218.4	326.6
FLGP-04-2	438.4	6:00	111.8	1:00	218.4	326.6
FLGP-03-2	438.4	6:00	111.8	1:00	218.4	326.6
FLGP-02-3	438.4	6:00	111.8	1:00	218.4	326.6
FLGP-01-2	438.4	6:00	111.8	1:00	218.4	326.6
FLGP-05-1	438.4	6:00	111.8	1:00	218.4	326.6
NVSN-01-3	190.1	6:00	48.5	1:00	94.7	141.6
NVSN-01-2	190.1	6:00	48.5	1:00	94.7	141.6
NVSN-01-4	190.1	6:00	48.5	1:00	94.7	141.6
NVSN-02-1	190.1	6:00	48.5	1:00	94.7	141.6
NVSN-02-2	190.1	6:00	48.5	1:00	94.7	141.6
NVSN-02-3	190.1	6:00	48.5	1:00	94.7	141.6
NVSN-03-1	190.1	6:00	48.5	1:00	94.7	141.6
NVSN-04-2	190.1	6:00	48.5	1:00	94.7	141.6
NVSN-01-1	190.1	6:00	48.5	1:00	94.7	141.6
VSCP-05-1	139.5	6:00	35.6	1:00	69.5	104

Table B-2. Node Pressure Ranges under Max Day Conditions – Water Supply Phase 1

ID	Max.Value (psi)	Max.Time (hrs)	Min.Value (psi)	Min.Time (hrs)	Average (psi)	Difference (psi)
FLGP-04-1	76.3	1:00	70.6	6:00	74.8	5.7
FLGP-03-1	78.5	1:00	72.7	6:00	76.9	5.8
FLGP-06-3	78.5	1:00	72.7	6:00	76.9	5.8
FLGP-04-2	78.5	1:00	72.8	6:00	76.9	5.7
FLGP-03-2	78.5	1:00	73.1	6:00	77	5.4
FLGP-02-3	74.3	1:00	69.3	6:00	72.9	5
FLGP-01-2	78.5	1:00	73.1	6:00	77	5.3
FLGP-05-1	78	1:00	72.1	6:00	76.4	6
NVSN-01-3	72	1:00	66.6	6:00	70.6	5.4
NVSN-01-2	74.2	1:00	68.8	6:00	72.7	5.4
NVSN-01-4	74.3	1:00	69.5	6:00	73	4.8
NVSN-02-1	76.4	1:00	71	6:00	74.9	5.4
NVSN-02-2	76.4	49:00:00	71	6:00	74.9	5.3
NVSN-02-3	76.4	49:00:00	70.9	6:00	74.8	5.5
NVSN-03-1	74.2	1:00	68.6	6:00	72.6	5.6
NVSN-04-2	68.1	1:00	64.7	6:00	67.1	3.3
NVSN-01-1	76.4	1:00	70.8	6:00	74.8	5.5
VSCP-05-1	57.6	1:00	56.1	6:00	57.1	1.5

Table B-3. Flow Ranges in Pipes under Max Day Conditions – Water Supply Phase 1

ID	Max.Value (gpm)	Max.Time (hrs)	Min.Value (gpm)	Min.Time (hrs)	Average (gpm)	Difference (gpm)
P-NV-114	3,997	0	1,423	2	2,305	2,574
P-NV-44	542	0	401	2	486	141
P-NV-45	689	1	3	1	249	686
Z40_P23	876	0	343	2	527	533
Z40_P-4254	592	1	5	3	202	588
Z40_P-4255	592	1	5	3	202	588
Z40_P87	438	0	112	0	218	327
Z40_TP-4003	250	1	0	3	71	250
Z40_TP-4004	689	1	3	1	249	686
Z40_TP-4200	438	0	112	0	218	327
Z40_TP-5005	1,693	0	571	2	938	1,123
Z40_TP-5006	1,693	0	571	2	938	1,123
Z40_TP-5011	1,256	0	440	2	716	816
Z40_TP-5014	1,197	0	325	2	600	873
Z40_TP-5016	1,256	0	440	2	716	816
Z40_TP-5023	725	2	449	2	580	276
Z40_TP-5024	2,112	0	822	2	1,275	1,290
Z40_TP-5025	2,112	0	822	2	1,275	1,290
Z40_TP-5027	2,551	2	934	2	1,493	1,617
Z40_TP-5029	3,997	0	1,423	2	2,305	2,574
Z40_TP-5036	0	0	0	0	0	0
Z40_TP-5037	0	0	0	0	0	0
Z40_TP-5079	1,197	0	325	2	600	873
Z40_TP-5080	1,007	0	276	2	505	731
Z40_TP-5082	542	0	401	2	486	141
Z40_TP-5120	876	0	343	2	527	533
Z40_TP-5121	1,256	0	440	2	716	816
Z40_TP-5123	190	1	49	1	95	142
Z40_TP-6027	3,997	0	1,423	2	2,305	2,574
Z40_TP-6030	4,187	0	1,471	2	2,399	2,716
Z40_TP-6034	4,187	0	1,471	2	2,399	2,716
Z40_TP-6036	140	2	36	1	70	104
Z40_TP-81	1,065	0	410	2	625	654
Z40_TP-84	1,503	0	522	2	843	981

Table B-4. Velocity Ranges in Pipes under Max Day Conditions – Water Supply Phase 1

ID	Max.Value (ft/s)	Max.Time (hrs)	Min.Value (ft/s)	Min.Time (hrs)	Average (ft/s)	Difference (ft/s)
P-NV-114	2.8	0.3	1.0	2.0	1.6	1.8
P-NV-44	0.9	0.5	0.6	2.0	0.8	0.2
P-NV-45	1.1	1.3	0.0	1.1	0.4	1.1
Z40_P23	1.1	0.3	0.4	2.0	0.7	0.7
Z40_P-4254	0.4	1.3	0.0	2.7	0.1	0.4
Z40_P-4255	0.4	1.3	0.0	2.7	0.1	0.4
Z40_P87	0.0	0.3	0.0	0.1	0.0	0.0
Z40_TP-4003	0.4	1.3	0.0	2.5	0.1	0.4
Z40_TP-4004	1.1	1.3	0.0	1.1	0.4	1.1
Z40_TP-4200	0.7	0.3	0.2	0.0	0.3	0.5
Z40_TP-5005	0.5	0.3	0.2	2.0	0.3	0.4
Z40_TP-5006	0.5	0.3	0.2	2.0	0.3	0.4
Z40_TP-5011	1.6	0.3	0.6	2.0	0.9	1.0
Z40_TP-5014	0.8	0.3	0.2	2.0	0.4	0.6
Z40_TP-5016	1.6	0.3	0.6	2.0	0.9	1.0
Z40_TP-5023	0.5	2.3	0.3	2.0	0.4	0.2
Z40_TP-5024	1.5	0.3	0.6	2.0	0.9	0.9
Z40_TP-5025	1.5	0.3	0.6	2.0	0.9	0.9
Z40_TP-5027	1.8	2.3	0.7	2.0	1.1	1.1
Z40_TP-5029	2.8	0.3	1.0	2.0	1.6	1.8
Z40_TP-5036	0.0	3.0	0.0	2.9	0.0	0.0
Z40_TP-5037	0.0	1.4	0.0	2.9	0.0	0.0
Z40_TP-5079	0.8	0.3	0.2	2.0	0.4	0.6
Z40_TP-5080	0.7	0.3	0.2	2.0	0.4	0.5
Z40_TP-5082	0.4	0.5	0.3	2.0	0.3	0.1
Z40_TP-5120	1.1	0.3	0.4	2.0	0.7	0.7
Z40_TP-5121	1.6	0.3	0.6	2.0	0.9	1.0
Z40_TP-5123	0.0	1.3	0.0	1.1	0.0	0.0
Z40_TP-6027	2.8	0.3	1.0	2.0	1.6	1.8
Z40_TP-6030	3.0	0.3	1.0	2.0	1.7	1.9
Z40_TP-6034	3.0	0.3	1.0	2.0	1.7	1.9
Z40_TP-6036	0.0	2.3	0.0	1.1	0.0	0.0
Z40_TP-81	0.8	0.3	0.3	2.0	0.4	0.5
Z40_TP-84	1.1	0.3	0.4	2.0	0.6	0.7

APPENDIX C

Modeling Results Scenario 2 – Water Supply Phase 2

Table C-1. Node Demand Ranges for Max Day Conditions – Water Supply Phase 2

ID	Max.Value (gpm)	Max.Time (hrs)	Min.Value (gpm)	Min.Time (hrs)	Average (gpm)	Difference (gpm)
FLGP-06-3	2,676.40	6:00	682.5	1:00	1,333.30	1,993.90
FLGP-06-1	2,676.40	6:00	682.5	1:00	1,333.30	1,993.90
FLGP-01-2	1,055.20	6:00	269.1	1:00	525.7	786.1
FLGP-01-1	1,055.20	6:00	269.1	1:00	525.6	786.1
FLGP-03-1	965.1	6:00	246.1	1:00	480.8	719
FLGP-03-2	965.1	6:00	246.1	1:00	480.8	719
FLGP-05-1	936.8	6:00	238.9	1:00	466.7	697.9
FLGP-02-1	871.6	6:00	222.3	1:00	434.2	649.3
FLGP-02-2	871.6	6:00	222.3	1:00	434.2	649.3
FLGP-02-3	871.6	6:00	222.3	1:00	434.2	649.3
FLGP-04-1	787.8	6:00	200.9	1:00	392.4	586.9
FLGP-04-2	787.8	6:00	200.9	1:00	392.4	586.9
NVSN-03-2	624	6:00	159.1	1:00	310.8	464.9
NVSN-03-1	624	6:00	159.1	1:00	310.8	464.9
NVSN-04-1	596.6	6:00	152.1	1:00	297.2	444.5
NVSN-04-3	596.6	6:00	152.1	1:00	297.2	444.5
NVSN-04-2	596.6	6:00	152.1	1:00	297.2	444.5
NVSN-02-3	369	6:00	94.1	1:00	183.8	274.9
NVSN-02-1	368.9	6:00	94.1	1:00	183.8	274.9
NVSN-02-2	368.9	6:00	94.1	1:00	183.8	274.9
NVSN-01-3	239.8	6:00	61.1	1:00	119.5	178.7
NVSN-01-4	239.8	6:00	61.1	1:00	119.5	178.7
NVSN-01-1	239.8	6:00	61.1	1:00	119.5	178.7
NVSN-01-2	239.7	6:00	61.1	1:00	119.4	178.6
VSCP-05-1	140.2	6:00	35.8	1:00	69.8	104.4

Table C-2. Node Pressure Ranges for Max Day Conditions – Water Supply Phase 2

ID	Max.Value (psi)	Max.Time (hrs)	Min.Value (psi)	Min.Time (hrs)	Average (psi)	Difference (psi)
FLGP-06-3	77.3	9:00	65.2	6:00	71.9	12
FLGP-06-1	73.7	9:00	62	6:00	67.8	11.6
FLGP-01-2	77.6	9:00	65.4	6:00	72	12.2
FLGP-01-1	76	9:00	62.9	6:00	70.3	13.1
FLGP-03-1	77.3	9:00	65.2	6:00	71.9	12
FLGP-03-2	77.6	9:00	65.4	6:00	71.9	12.2
FLGP-05-1	76.8	9:00	67.5	6:00	72.5	9.3
FLGP-02-1	75.1	9:00	61.9	6:00	69.3	13.2
FLGP-02-2	64.3	9:00	51.1	6:00	58.5	13.2
FLGP-02-3	73.7	9:00	62.1	6:00	67.9	11.6
FLGP-04-1	75.3	9:00	63.3	6:00	69.8	11.9
FLGP-04-2	77.3	9:00	65.2	6:00	71.9	12.1
NVSN-03-2	71.5	9:00:00	59.8	6:00	65.7	11.6
NVSN-03-1	73.4	9:00:00	61.7	6:00	67.8	11.7
NVSN-04-1	73.1	9:00	61.7	20:00	66.4	11.4
NVSN-04-3	68.1	9:00	57.3	20:00	61.8	10.8
NVSN-04-2	68.8	9:00	57.4	20:00	62	11.4
NVSN-02-3	75.6	9:00	63.8	6:00	69.9	11.8
NVSN-02-1	75.5	9:00	63.6	54:00:00	69.8	11.9
NVSN-02-2	75.6	9:00	63.7	6:00	69.9	11.8
NVSN-01-3	71.3	9:00	59.7	6:00	65.6	11.7
NVSN-01-4	73.9	9:00:00	62.4	6:00	68	11.4
NVSN-01-1	75.6	9:00	63.9	6:00	69.9	11.7
NVSN-01-2	73.5	9:00	61.8	6:00	67.8	11.7
VSCP-05-1	60.5	9:00	46.7	20:00	51.9	13.9

Table C-3. Flow Ranges in Pipes under Max Day Conditions – Water Supply Phase 2

ID	Max.Value (gpm)	Max.Time (hrs)	Min.Value (gpm)	Min.Time (hrs)	Average (gpm)	Difference (gpm)
P-NV-101	1,927	20:00	11	32:00:00	980	1,916
P-NV-113	5,742	54:00:00	1,178	1:00	2,675	4,564
P-NV-114	4,941	54:00:00	956	1:00	2,305	3,985
P-NV-44	1,197	54:00:00	86	0:00	439	1,111
P-NV-45	750	8:00	28	41:00:00	333	722
P-NV-49	4,500	6:00	0	2:00	2,328	4,500
P-NV-84	0	0:00	0	0:00	0	0
P-Z40-29	597	6:00	152	1:00	297	445
P-Z40-67	624	6:00	159	1:00	311	465
Z40_P23	769	8:00	5	52:00:00	298	763
Z40_P-4254	1,142	4:00	10	65:00:00	408	1,132
Z40_P-4255	1,142	4:00	10	65:00:00	408	1,132
Z40_P79	1,526	54:00:00	109	2:00	748	1,417
Z40_P81	2,676	6:00	683	1:00	1,333	1,994
Z40_P85	597	6:00	152	27:00:00	297	445
Z40_P87	2,676	6:00	683	1:00	1,333	1,994
Z40_TP-253	2,682	54:00:00	199	25:00:00	1,398	2,483
Z40_TP-4003	407	20:00	10	49:00:00	160	397
Z40_TP-4004	750	8:00	28	41:00:00	333	722
Z40_TP-4200	1,902	20:00	40	25:00:00	940	1,862
Z40_TP-4201	2,682	54:00:00	199	25:00:00	1,398	2,483
Z40_TP-4202	1,927	20:00	11	32:00:00	980	1,916
Z40_TP-5005	1,033	20:00	5	15:00	444	1,028
Z40_TP-5006	1,033	20:00	5	15:00	444	1,028
Z40_TP-5011	1,181	54:00:00	190	52:00:00	537	991
Z40_TP-5014	822	20:00	0	26:00:00	365	822
Z40_TP-5016	1,181	54:00:00	190	52:00:00	537	991
Z40_TP-5023	1,566	54:00:00	106	3:00	610	1,460
Z40_TP-5024	1,346	8:00	42	52:00:00	466	1,304
Z40_TP-5025	2,649	54:00:00	385	4:00	1,214	2,264
Z40_TP-5027	3,521	54:00:00	646	1:00	1,648	2,874
Z40_TP-5029	4,941	54:00:00	956	1:00	2,305	3,985
Z40_TP-5036	6,338	54:00:00	1,330	1:00	2,972	5,008
Z40_TP-5037	6,338	54:00:00	1,330	1:00	2,972	5,008
Z40_TP-5040	471	54:00:00	30	1:00	233	442
Z40_TP-5079	822	20:00	0	26:00:00	365	822
Z40_TP-5080	1,181	54:00:00	31	57:00:00	517	1,151
Z40_TP-5082	1,197	54:00:00	86	0:00	439	1,111
Z40_TP-5088	872	6:00	222	3:00	434	649
Z40_TP-5120	769	8:00	5	52:00:00	298	763
Z40_TP-5121	1,181	54:00:00	190	52:00:00	537	991
Z40_TP-5123	240	6:00	61	1:00	120	179
Z40_TP-5200	1,927	20:00	11	32:00:00	980	1,916
Z40_TP-6027	4,394	54:00:00	1	4:00	961	4,393
Z40_TP-6030	5,588	54:00:00	347	60:00:00	1,476	5,240
Z40_TP-6034	5,588	54:00:00	347	60:00:00	1,476	5,240
Z40_TP-6036	140	30:00:00	36	27:00:00	70	104
Z40_TP-62	597	6:00	152	1:00	297	445
Z40_TP-81	2,128	54:00:00	256	52:00:00	942	1,873
Z40_TP-84	2,916	54:00:00	539	50:00:00	1,335	2,377
Z40_TP-87	2,625	8:00	40	4:00	1,031	2,585
Z40_TP-89	5,742	54:00:00	1,178	1:00	2,675	4,564

Table C-4. Velocity Ranges in Pipes under Max Day Conditions – Water Supply Phase 2

ID	Max.Value (ft/s)	Max.Time (hrs)	Min.Value (ft/s)	Min.Time (hrs)	Average (ft/s)	Difference (ft/s)
P-NV-101	1.4	20:00	0.0	32:00:00	0.7	1.4
P-NV-113	4.1	54:00:00	0.8	1:00	1.9	3.2
P-NV-114	3.5	54:00:00	0.7	1:00	1.6	2.8
P-NV-44	1.9	54:00:00	0.1	0:00	0.7	1.8
P-NV-45	1.2	8:00	0.0	41:00:00	0.5	1.2
P-NV-49	3.2	6:00	0.0	2:00	1.7	3.2
P-NV-84	0.0	0:00	0.0	0:00	0.0	0.0
P-Z40-29	0.1	6:00	0.0	1:00	0.0	0.1
P-Z40-67	0.0	6:00	0.0	1:00	0.0	0.0
Z40_P23	1.0	8:00	0.0	52:00:00	0.4	1.0
Z40_P-4254	0.8	4:00	0.0	65:00:00	0.3	0.8
Z40_P-4255	0.8	4:00	0.0	65:00:00	0.3	0.8
Z40_P79	2.4	54:00:00	0.2	2:00	1.2	2.3
Z40_P81	0.1	6:00	0.0	1:00	0.1	0.1
Z40_P85	0.0	6:00	0.0	27:00:00	0.0	0.0
Z40_P87	0.1	6:00	0.0	1:00	0.1	0.1
Z40_TP-253	4.3	54:00:00	0.3	25:00:00	2.2	4.0
Z40_TP-4003	0.6	20:00	0.0	49:00:00	0.3	0.6
Z40_TP-4004	1.2	8:00	0.0	41:00:00	0.5	1.2
Z40_TP-4200	3.0	20:00	0.1	25:00:00	1.5	3.0
Z40_TP-4201	4.3	54:00:00	0.3	25:00:00	2.2	4.0
Z40_TP-4202	3.1	20:00	0.0	32:00:00	1.6	3.1
Z40_TP-5005	0.3	20:00	0.0	15:00	0.1	0.3
Z40_TP-5006	0.3	20:00	0.0	15:00	0.1	0.3
Z40_TP-5011	1.5	54:00:00	0.2	52:00:00	0.7	1.2
Z40_TP-5014	0.6	20:00	0.0	26:00:00	0.3	0.6
Z40_TP-5016	1.5	54:00:00	0.2	52:00:00	0.7	1.2
Z40_TP-5023	1.1	54:00:00	0.1	3:00	0.4	1.0
Z40_TP-5024	1.0	8:00	0.0	52:00:00	0.3	0.9
Z40_TP-5025	1.9	54:00:00	0.3	4:00	0.9	1.6
Z40_TP-5027	2.5	54:00:00	0.5	1:00	1.2	2.0
Z40_TP-5029	3.5	54:00:00	0.7	1:00	1.6	2.8
Z40_TP-5036	1.1	54:00:00	0.2	1:00	0.5	0.9
Z40_TP-5037	1.1	54:00:00	0.2	1:00	0.5	0.9
Z40_TP-5040	0.8	54:00:00	0	1:00	0.4	0.7
Z40_TP-5079	0.6	20:00	0	26:00:00	0.3	0.6
Z40_TP-5080	0.8	54:00:00	0	57:00:00	0.4	0.8
Z40_TP-5082	0.8	54:00:00	0.1	0:00	0.3	0.8
Z40_TP-5088	0	6:00	0	3:00	0	0
Z40_TP-5120	1	8:00	0	52:00:00	0.4	1
Z40_TP-5121	1.5	54:00:00	0.2	52:00:00	0.7	1.2
Z40_TP-5123	0	6:00	0	1:00	0	0
Z40_TP-5200	3.1	20:00	0	32:00:00	1.6	3.1
Z40_TP-6027	3.1	54:00:00	0	4:00	0.7	3.1
Z40_TP-6030	4	54:00:00	0.2	60:00:00	1	3.7
Z40_TP-6034	4	54:00:00	0.2	60:00:00	1	3.7
Z40_TP-6036	0	30:00:00	0	27:00:00	0	0
Z40_TP-62	0	6:00	0	1:00	0	0
Z40_TP-81	1.5	54:00:00	0.2	52:00:00	0.7	1.3
Z40_TP-84	2.1	54:00:00	0.4	50:00:00	0.9	1.7
Z40_TP-87	1.9	8:00	0	4:00	0.7	1.8
Z40_TP-89	4.1	54:00:00	0.8	1:00	1.9	3.2

APPENDIX D

Modeling Results Scenario 3 – Water Supply Phase 3

Table D-1. Node Demand Ranges under Max Day Conditions – Water Supply Phase 3

ID	Max.Value (gpm)	Max.Time (hrs)	Min.Value (gpm)	Min.Time (hrs)	Average (gpm)	Difference (gpm)
FLGP-06-1	2,676.40	6:00	682.5	1:00	1,333.30	1,993.90
FLGP-06-3	2,676.30	6:00	682.5	1:00	1,333.20	1,993.90
FLGP-01-2	1,055.20	6:00	269.1	1:00	525.7	786.1
FLGP-01-1	1,055.20	6:00	269.1	1:00	525.6	786.1
FLGP-03-1	965.1	6:00	246.1	1:00	480.8	719
FLGP-03-2	965.1	6:00	246.1	1:00	480.8	719
FLGP-05-1	936.8	6:00	238.9	1:00	466.7	697.9
FLGP-02-1	871.6	6:00	222.3	1:00	434.2	649.3
FLGP-02-2	871.6	6:00	222.3	1:00	434.2	649.3
FLGP-02-3	871.6	6:00	222.3	1:00	434.2	649.3
FLGP-04-1	787.8	6:00	200.9	1:00	392.4	586.9
FLGP-04-2	787.8	6:00	200.9	1:00	392.4	586.9
NVSN-03-2	624	6:00	159.1	1:00	310.8	464.9
NVSN-03-1	624	6:00	159.1	1:00	310.8	464.9
NVSN-04-1	596.6	6:00	152.1	1:00	297.2	444.5
NVSN-04-3	596.6	6:00	152.1	1:00	297.2	444.5
NVSN-04-2	596.6	6:00	152.1	1:00	297.2	444.5
NVSN-02-3	369	6:00	94.1	1:00	183.8	274.9
NVSN-02-1	368.9	6:00	94.1	1:00	183.8	274.9
NVSN-02-2	368.9	6:00	94.1	1:00	183.8	274.9
NVSN-01-3	239.8	6:00	61.1	1:00	119.5	178.7
NVSN-01-4	239.8	6:00	61.1	1:00	119.5	178.7
NVSN-01-1	239.8	6:00	61.1	1:00	119.5	178.7
NVSN-01-2	239.7	6:00	61.1	1:00	119.4	178.6
VSCP-05-1	140.2	6:00	35.8	1:00	69.8	104.4

Table D-2. Node Pressure Ranges for Max Day Conditions – Water Supply Phase 3

ID	Max.Value (psi)	Max.Time (hrs)	Min.Value (psi)	Min.Time (hrs)	Average (psi)	Difference (psi)
FLGP-06-1	73.3	1:00	65.7	6:00	71.8	7.7
FLGP-06-3	77.6	1:00	66.4	6:00	75.2	11.2
FLGP-01-2	78.2	1:00	66.9	6:00	75.4	11.4
FLGP-01-1	76	1:00	61.6	6:00	72.8	14.4
FLGP-03-1	77.6	1:00	66.4	6:00	75.2	11.2
FLGP-03-2	77.9	1:00	66.9	6:00	75.4	11.1
FLGP-05-1	77.1	1:00	66	6:00	74.7	11.1
FLGP-02-1	74.9	1:00	58.5	6:00	71.3	16.4
FLGP-02-2	64.1	1:00	47.7	6:00	60.4	16.4
FLGP-02-3	73.4	1:00	65	6:00	71.7	8.3
FLGP-04-1	75.4	1:00	64.9	6:00	73.2	10.5
FLGP-04-2	77.7	1:00	66.4	6:00	75.2	11.3
NVSN-03-2	71.2	1:00:00	63.5	6:00	69.6	7.7
NVSN-03-1	73.3	1:00:00	64	6:00	71.4	9.3
NVSN-04-1	71.4	1:00	66.6	6:00	70.6	4.9
NVSN-04-3	67	1:00	65.2	6:00	66.9	1.8
NVSN-04-2	67.1	1:00	62.2	6:00	66.2	4.9
NVSN-02-3	75.5	1:00	66	6:00	73.5	9.5
NVSN-02-1	75.6	1:00	65.6	54:00:00	73.4	10
NVSN-02-2	75.5	1:00	65.9	6:00	73.5	9.6
NVSN-01-3	71.2	1:00	62.1	6:00	69.3	9
NVSN-01-4	73.4	1:00:00	65.6	6:00	71.8	7.8
NVSN-01-1	75.5	1:00	66.1	6:00	73.5	9.3
NVSN-01-2	73.3	1:00	64.3	6:00	71.4	9
VSCP-05-1	56.7	1:00	51.4	6:00	55.6	5.3

Table D-3. Flow Ranges in Pipes under Max Day Condition – Water Supply Phase 3

ID	Max.Value (gpm)	Max.Time (hrs)	Min.Value (gpm)	Min.Time (hrs)	Average (gpm)	Difference (gpm)
P-NV-101	872	2	168	0	414	705
P-NV-113	9,701	2	1,484	0	4,537	8,217
P-NV-114	7,163	2	1,161	0	3,409	6,003
P-NV-44	1,901	2	128	2	739	1,774
P-NV-45	1,060	0	346	0	551	714
P-NV-49	0	0	0	0	0	0
P-NV-84	0	0	0	0	0	0
P-Z40-29	29,187	2	49	0	12,476	29,138
P-Z40-67	624	0	159	0	311	465
Z40_P23	1,320	0	225	0	626	1,095
Z40_P-4254	1,634	0	7	3	471	1,626
Z40_P-4255	1,634	0	7	3	471	1,626
Z40_P79	2,798	0	714	1	1,394	2,085
Z40_P81	2,676	0	683	0	1,333	1,994
Z40_P85	597	0	152	0	297	445
Z40_P87	2,676	0	683	0	1,333	1,994
Z40_TP-253	872	2	168	0	414	705
Z40_TP-4003	365	0	9	3	170	356
Z40_TP-4004	1,060	0	346	0	551	714
Z40_TP-4200	100	0	7	3	53	93
Z40_TP-4201	872	2	168	0	414	705
Z40_TP-4202	872	2	168	0	414	705
Z40_TP-5005	520	0	0	2	186	519
Z40_TP-5006	520	0	0	2	186	519
Z40_TP-5011	1,799	0	347	0	865	1,452
Z40_TP-5014	1,179	2	95	2	465	1,084
Z40_TP-5016	1,799	0	347	0	865	1,452
Z40_TP-5023	2,270	2	25	2	890	2,246
Z40_TP-5024	1,461	2	93	1	609	1,368
Z40_TP-5025	4,259	2	530	0	1,990	3,729
Z40_TP-5027	5,131	2	753	0	2,425	4,378
Z40_TP-5029	7,163	2	1,161	0	3,409	6,003
Z40_TP-5036	19,486	2	757	0	8,045	18,729
Z40_TP-5037	19,486	2	757	0	8,045	18,729
Z40_TP-5040	1,743	0	445	1	868	1,299
Z40_TP-5079	1,179	2	95	2	465	1,084
Z40_TP-5080	1,548	2	9	2	617	1,539
Z40_TP-5082	1,901	2	128	2	739	1,774
Z40_TP-5088	872	0	222	0	434	649
Z40_TP-5120	1,320	0	225	0	626	1,095
Z40_TP-5121	1,799	0	347	0	865	1,452
Z40_TP-5123	240	0	61	0	120	179
Z40_TP-5200	872	2	168	0	414	705
Z40_TP-6027	1,370	0	2	2	611	1,367
Z40_TP-6030	1,674	0	46	2	1,093	1,628
Z40_TP-6034	1,674	0	46	2	1,093	1,628
Z40_TP-6036	140	0	36	1	70	104
Z40_TP-62	597	0	152	0	297	445
Z40_TP-81	3,643	2	635	0	1,709	3,008
Z40_TP-84	4,431	2	836	0	2,101	3,595
Z40_TP-87	6,401	2	643	0	2,892	5,758
Z40_TP-89	9,701	2	1,484	0	4,537	8,217

**Table D-4. Velocity Ranges s in Pipes under Max Day Condition –
Water Supply Phase 3**

ID	Max.Value (ft/s)	Max.Time (hrs)	Min.Value (ft/s)	Min.Time (hrs)	Average (ft/s)	Difference (ft/s)
P-NV-101	0.6	2.3	0.1	0.0	0.3	0.5
P-NV-113	6.9	2.3	1.1	0.0	3.2	5.8
P-NV-114	5.1	2.3	0.8	0.0	2.4	4.3
P-NV-44	3.0	2.3	0.2	2.1	1.2	2.8
P-NV-45	1.7	0.3	0.6	0.4	0.9	1.1
P-NV-49	0.0	0.8	0.0	1.8	0.0	0.0
P-NV-84	0.0	0.0	0.0	0.0	0.0	0.0
P-Z40-29	3.3	2.3	0.0	0.1	1.4	3.3
P-Z40-67	0.0	0.3	0.0	0.0	0.0	0.0
Z40_P23	1.7	0.3	0.3	0.0	0.8	1.4
Z40_P-4254	1.2	0.0	0.0	3.0	0.3	1.2
Z40_P-4255	1.2	0.0	0.0	3.0	0.3	1.2
Z40_P79	4.5	0.3	1.1	1.1	2.2	3.3
Z40_P81	0.1	0.3	0.0	0.0	0.1	0.1
Z40_P85	0.0	0.3	0.0	0.0	0.0	0.0
Z40_P87	0.1	0.3	0.0	0.0	0.1	0.1
Z40_TP-253	1.4	2.3	0.3	0.0	0.7	1.1
Z40_TP-4003	0.6	0.0	0.0	2.9	0.3	0.6
Z40_TP-4004	1.7	0.3	0.6	0.4	0.9	1.1
Z40_TP-4200	0.2	0.3	0.0	2.8	0.1	0.1
Z40_TP-4201	1.4	2.3	0.3	0.0	0.7	1.1
Z40_TP-4202	1.4	2.3	0.3	0.0	0.7	1.1
Z40_TP-5005	0.2	0.0	0.0	2.0	0.1	0.2
Z40_TP-5006	0.2	0.0	0.0	2.0	0.1	0.2
Z40_TP-5011	2.3	0.3	0.4	0.0	1.1	1.8
Z40_TP-5014	0.8	2.3	0.1	2.1	0.3	0.8
Z40_TP-5016	2.3	0.3	0.4	0.0	1.1	1.8
Z40_TP-5023	1.6	2.3	0.0	2.1	0.6	1.6
Z40_TP-5024	1.0	2.3	0.1	1.0	0.4	1.0
Z40_TP-5025	3.0	2.3	0.4	0.0	1.4	2.6
Z40_TP-5027	3.6	2.3	0.5	0.0	1.7	3.1
Z40_TP-5029	5.1	2.3	0.8	0.0	2.4	4.3
Z40_TP-5036	3.5	2.3	0.1	0.0	1.4	3.3
Z40_TP-5037	3.5	2.3	0.1	0.0	1.4	3.3
Z40_TP-5040	2.8	6:00	0.7	27:00:00	1.4	2.1
Z40_TP-5079	0.8	54:00:00	0.1	50:00:00	0.3	0.8
Z40_TP-5080	1.1	54:00:00	0	50:00:00	0.4	1.1
Z40_TP-5082	1.3	54:00:00	0.1	50:00:00	0.5	1.3
Z40_TP-5088	0	6:00	0	0	0	0
Z40_TP-5120	1.7	6:00	0.3	1:00	0.8	1.4
Z40_TP-5121	2.3	6:00	0.4	1:00	1.1	1.8
Z40_TP-5123	0	6:00	0	1:00	0	0
Z40_TP-5200	1.4	54:00:00	0.3	1:00	0.7	1.1
Z40_TP-6027	1	1:00	0	56:00:00	0.4	1
Z40_TP-6030	1.2	1:00	0	54:00:00	0.8	1.2
Z40_TP-6034	1.2	1:00	0	54:00:00	0.8	1.2
Z40_TP-6036	0	6:00	0	27:00:00	0	0
Z40_TP-62	0	6:00	0	1:00	0	0
Z40_TP-81	2.6	54:00:00	0.5	1:00	1.2	2.1
Z40_TP-84	3.1	54:00:00	0.6	1:00	1.5	2.5
Z40_TP-87	4.5	54:00:00	0.5	1:00	2.1	4.1
Z40_TP-89	6.9	54:00:00	1.1	1:00	3.2	5.8

APPENDIX E

Modeling Results Scenario 4 – Water Supply Phase 4

Table E-1. Node Demand Ranges under Max Day Conditions – Water Supply Phase 4

ID	Max.Value (gpm)	Max.Time (hrs)	Min.Value (gpm)	Min.Time (hrs)	Average (gpm)	Difference (gpm)
FLGP-06-2	2,257.60	6:00	575.7	1:00	1,124.60	1,681.90
FLGP-06-1	2,257.60	6:00	575.7	1:00	1,124.60	1,681.90
FLGP-06-3	2,257.00	6:00	575.5	1:00	1,124.30	1,681.50
FLGP-06-4	2,257.00	6:00	575.5	1:00	1,124.30	1,681.50
NVSN-04-2	1,485.60	6:00	378.8	1:00	740.1	1,106.80
NVSN-04-1	1,484.80	6:00	378.6	1:00	739.7	1,106.20
NVSN-04-3	1,484.80	6:00	378.6	1:00	739.7	1,106.20
FLGP-04-2	1,282.20	6:00	327	1:00	638.7	955.2
FLGP-01-2	1,282.20	6:00	327	1:00	638.7	955.2
FLGP-01-1	1,282.20	6:00	327	1:00	638.7	955.2
FLGP-04-1	1,281.40	6:00	326.8	1:00	638.3	954.6
FLGP-05-1	1,251.20	6:00	319.1	1:00	623.3	932.1
FLGP-02-3	1,170.00	6:00	298.4	1:00	582.8	871.7
FLGP-02-1	1,170.00	6:00	298.4	1:00	582.8	871.7
FLGP-02-2	1,170.00	6:00	298.4	1:00	582.8	871.7
NTDA-08-2	1,075.40	6:00	274.2	1:00	535.7	801.2
NTDA-08-1	1,075.00	6:00	274.1	1:00	535.5	800.9
FLGP-03-1	1,041.00	6:00	265.5	1:00	518.6	775.5
FLGP-03-2	1,041.00	6:00	265.5	1:00	518.6	775.5
NVSN-03-2	1,014.80	6:00	258.8	1:00	505.5	756
NVSN-03-1	1,014.80	6:00	258.8	1:00	505.5	756
NTDA-09-01	882.8	6:00	225.1	1:00	439.8	657.7
VSCP-05-1	820.8	6:00	209.3	1:00	408.9	611.5
NTDA-10-1	653.6	6:00	166.7	1:00	325.6	486.9
NTDA-10-7	653.6	6:00	166.7	1:00	325.6	486.9
NTDA-10-5	653.6	6:00	166.7	1:00	325.6	486.9
NTDA-10-3	653.6	6:00	166.7	1:00	325.6	486.9
NVSN-02-3	600.8	6:00	153.2	1:00	299.3	447.6
NVSN-02-2	600.8	6:00	153.2	1:00	299.3	447.6
NVSN-02-1	600.8	6:00	153.2	1:00	299.3	447.6
NVSN-01-4	390	6:00	99.4	1:00	194.3	290.6
NVSN-01-3	390	6:00	99.4	1:00	194.3	290.6
NVSN-01-2	390	6:00	99.4	1:00	194.3	290.6
NVSN-01-1	390	6:00	99.4	1:00	194.3	290.6

Table E-2. Node Pressure Ranges under Max Day Conditions – Water Supply Phase 4

ID	Max.Value (psi)	Max.Time (hrs)	Min.Value (psi)	Min.Time (hrs)	Average (psi)	Difference (psi)
FLGP-06-2	71.3	3:00	58.5	30:00:00	67.4	12.8
FLGP-06-1	73.7	3:00	61.2	30:00:00	69.9	12.5
FLGP-06-3	77.7	3:00	63.6	30:00:00	73.5	14.1
FLGP-06-4	75.4	3:00	62.9	30:00:00	71.5	12.5
NVSN-04-2	78.6	27:00:00	63.5	54:00:00	67.1	15.1
NVSN-04-1	82.9	27:00:00	67.8	54:00:00	71.5	15.1
NVSN-04-3	78.7	27:00:00	64.2	54:00:00	67.5	14.5
FLGP-04-2	77.6	3:00	61.3	30:00:00	72.9	16.3
FLGP-01-2	77.6	3:00	61.1	30:00:00	72.9	16.5
FLGP-01-1	75.8	3:00	52.7	30:00:00	69.5	23.1
FLGP-04-1	75.7	3:00	62.2	30:00:00	71.6	13.5
FLGP-05-1	77.1	3:00	64.3	30:00:00	73.2	12.8
FLGP-02-3	73.5	3:00	58.2	30:00:00	69	15.3
FLGP-02-1	74.7	3:00	48.1	30:00:00	67.5	26.5
FLGP-02-2	63.8	3:00	37.3	30:00:00	56.7	26.5
NTDA-08-2	82.9	27:00:00	67.5	54:00:00	71.5	15.4
NTDA-08-1	82.9	27:00:00	67.9	54:00:00	71.6	15.1
FLGP-03-1	77.7	3:00	63.6	30:00:00	73.5	14.1
FLGP-03-2	77.6	3:00	61.3	30:00:00	72.9	16.4
NVSN-03-2	71.5	3:00	59	30:00:00	67.7	12.5
NVSN-03-1	73.7	3:00	61.6	30:00:00	70	12.1
NTDA-09-01	75.1	27:00:00	59.9	54:00:00	63.8	15.2
VSCP-05-1	68.3	27:00:00	53.5	41:00:00	56.8	14.8
NTDA-10-1	71.6	27:00:00	56	54:00:00	60.2	15.6
NTDA-10-7	78.6	27:00:00	63.2	54:00:00	67.2	15.3
NTDA-10-5	76.5	27:00:00	62	54:00:00	65.4	14.5
NTDA-10-3	77.8	27:00:00	63.1	54:00:00	66.4	14.7
NVSN-02-3	75.9	3:00	63.5	30:00:00	72.1	12.5
NVSN-02-2	75.6	3:00	60.5	30:00:00	71.2	15.2
NVSN-02-1	75.6	3:00	60.1	30:00:00	71.1	15.5
NVSN-01-4	73.5	3:00	58.3	30:00:00	69.1	15.1
NVSN-01-3	71.5	3:00	58.8	30:00:00	67.7	12.8
NVSN-01-2	73.7	3:00	60.9	30:00:00	69.9	12.8
NVSN-01-1	76	3:00	65	30:00:00	72.6	11

Table E-3. Flow Ranges in Pipes under Max Day Conditions – Water Supply Phase 4

ID	Max.Value (gpm)	Max.Time (hrs)	Min.Value (gpm)	Min.Time (hrs)	Average (gpm)	Difference (gpm)
P-NV-101	2,330	6:00	485	52:00:00	1,496	1,845
P-NV-113	0	0:00	0	0:00	0	0
P-NV-114	0	0:00	0	0:00	0	0
P-NV-44	1,994	6:00	668	51:00:00	1,098	1,326
P-NV-45	346	67:00:00	10	36:00:00	132	336
P-NV-49	4,500	6:00	0	1:00	1,472	4,500
P-NV-84	21,892	6:00	6,730	51:00:00	11,675	15,162
P-Z40-29	12,271	5:00	2,448	65:00:00	5,840	9,823
P-Z40-39	883	6:00	225	1:00	440	658
P-Z40-67	1,015	6:00	259	1:00	506	756
Z40_P23	3,359	6:00	904	51:00:00	1,704	2,455
Z40_P-279	2,683	6:00	690	49:00:00	1,343	1,994
Z40_P-4254	1,282	6:00	327	49:00:00	639	955
Z40_P-4255	1,282	6:00	327	49:00:00	639	955
Z40_P79	3,622	6:00	924	25:00:00	1,804	2,699
Z40_P81	2,258	6:00	576	1:00	1,125	1,682
Z40_P83	0	0:00	0	0:00	0	0
Z40_P85	1,485	6:00	379	1:00	740	1,106
Z40_P87	2,257	6:00	576	1:00	1,124	1,682
Z40_RCP-01A	1,940	54:00:00	487	1:00	960	1,453
Z40_RCP-01B	865	54:00:00	213	1:00	424	652
Z40_RCP-03A	654	6:00	167	1:00	326	487
Z40_TP137	212	6:00	59	49:00:00	112	152
Z40_TP-253	2,315	6:00	3	16:00	754	2,313
Z40_TP-4003	1,611	6:00	251	49:00:00	699	1,360
Z40_TP-4004	346	67:00:00	10	36:00:00	132	336
Z40_TP-4200	1,351	67:00:00	13	46:00:00	500	1,338
Z40_TP-4201	2,315	6:00	3	16:00	754	2,313
Z40_TP-4202	2,317	67:00:00	67	27:00:00	753	2,250
Z40_TP-5005	11,744	6:00	3,870	52:00:00	6,515	7,874
Z40_TP-5006	11,744	6:00	3,870	52:00:00	6,515	7,874
Z40_TP-5011	2,579	6:00	705	51:00:00	1,316	1,874
Z40_TP-5014	5,799	6:00	1,591	51:00:00	2,962	4,208
Z40_TP-5016	2,579	6:00	705	51:00:00	1,316	1,874
Z40_TP-5023	2,595	6:00	821	49:00:00	1,397	1,774
Z40_TP-5024	2,603	6:00	616	25:00:00	1,266	1,987
Z40_TP-5025	1,019	6:00	307	3:00	539	712
Z40_TP-5027	2,189	6:00	606	3:00	1,122	1,584
Z40_TP-5029	0	0:00	0	0:00	0	0
Z40_TP-5036	11,050	5:00	1,475	65:00:00	4,881	9,576
Z40_TP-5037	11,050	5:00	1,475	65:00:00	4,881	9,576
Z40_TP-5040	2,340	6:00	597	25:00:00	1,166	1,743
Z40_TP-5079	5,799	6:00	1,591	51:00:00	2,962	4,208
Z40_TP-5080	6,400	6:00	1,744	51:00:00	3,261	4,656
Z40_TP-5082	1,994	6:00	668	51:00:00	1,098	1,326
Z40_TP-5088	1,170	6:00	298	1:00	583	872
Z40_TP-5120	3,359	6:00	904	51:00:00	1,704	2,455
Z40_TP-5121	2,579	6:00	705	51:00:00	1,316	1,874
Z40_TP-5123	390	6:00	99	1:00	194	291
Z40_TP-5200	816	67:00:00	35	57:00:00	489	782
Z40_TP-6027	3,245	32:00:00	142	50:00:00	1,428	3,103
Z40_TP-6030	3,730	5:00	8	41:00:00	853	3,722
Z40_TP-6034	5,355	29:00:00	354	41:00:00	1,547	5,000
Z40_TP-6036	821	6:00	209	1:00	409	612
Z40_TP-6148	1,519	6:00	393	49:00:00	763	1,126
Z40_TP-62	1,485	6:00	379	1:00	740	1,106
Z40_TP-81	3,845	6:00	1,242	52:00:00	2,246	2,604
Z40_TP-84	5,127	6:00	1,735	52:00:00	2,884	3,392
Z40_TP-87	3,272	6:00	835	27:00:00	1,630	2,438
Z40_TP-89	0	0:00	0	0:00	0	0

Table E-4 Velocity Ranges in Pipes under Max Day Conditions – Water Supply Phase 4

ID	Max.Value (ft/s)	Max.Time (hrs)	Min.Value (ft/s)	Min.Time (hrs)	Average (ft/s)	Difference (ft/s)
P-NV-101	1.7	6:00	0.3	52:00:00	1.1	1.3
P-NV-113	0.0	36:00:00	0.0	63:00:00	0.0	0.0
P-NV-114	0.0	44:00:00	0.0	62:00:00	0.0	0.0
P-NV-44	3.2	6:00	1.1	51:00:00	1.8	2.1
P-NV-45	0.6	67:00:00	0.0	36:00:00	0.2	0.5
P-NV-49	3.2	6:00	0.0	1:00	1.0	3.2
P-NV-84	3.9	6:00	1.2	51:00:00	2.1	2.7
P-Z40-29	1.4	5:00	0.3	65:00:00	0.7	1.1
P-Z40-39	0.0	6:00	0.0	1:00	0.0	0.0
P-Z40-67	0.0	6:00	0.0	1:00	0.0	0.0
Z40_P23	4.2	6:00	1.1	51:00:00	2.1	3.1
Z40_P-279	1.9	6:00	0.5	49:00:00	1.0	1.4
Z40_P-4254	0.9	6:00	0.2	49:00:00	0.5	0.7
Z40_P-4255	0.9	6:00	0.2	49:00:00	0.5	0.7
Z40_P79	5.8	6:00	1.5	25:00:00	2.9	4.3
Z40_P81	0.1	6:00	0.0	1:00	0.0	0.1
Z40_P83	0.0	6:00	0.0	38:00:00	0.0	0.0
Z40_P85	0.1	6:00	0.0	1:00	0.0	0.0
Z40_P87	0.1	6:00	0.0	1:00	0.0	0.1
Z40_RCP-01A	1.4	54:00:00	0.3	1:00	0.7	1.0
Z40_RCP-01B	1.4	54:00:00	0.3	1:00	0.7	1.0
Z40_RCP-03A	1.0	6:00	0.3	1:00	0.5	0.8
Z40_TP137	0.3	6:00	0.1	49:00:00	0.2	0.2
Z40_TP-253	3.7	6:00	0.0	16:00	1.2	3.7
Z40_TP-4003	2.6	6:00	0.4	49:00:00	1.1	2.2
Z40_TP-4004	0.6	67:00:00	0.0	36:00:00	0.2	0.5
Z40_TP-4200	2.2	67:00:00	0.0	46:00:00	0.8	2.1
Z40_TP-4201	3.7	6:00	0.0	16:00	1.2	3.7
Z40_TP-4202	3.7	67:00:00	0.1	27:00:00	1.2	3.6
Z40_TP-5005	3.7	6:00	1.2	52:00:00	2.1	2.5
Z40_TP-5006	3.7	6:00	1.2	52:00:00	2.1	2.5
Z40_TP-5011	3.3	6:00	0.9	51:00:00	1.7	2.4
Z40_TP-5014	4.1	6:00	1.1	51:00:00	2.1	3.0
Z40_TP-5016	3.3	6:00	0.9	51:00:00	1.7	2.4
Z40_TP-5023	1.8	6:00	0.6	49:00:00	1	1.3
Z40_TP-5024	1.8	6:00	0.4	25:00:00	0.9	1.4
Z40_TP-5025	0.7	6:00	0.2	3:00	0.4	0.5
Z40_TP-5027	1.6	6:00	0.4	3:00	0.8	1.1
Z40_TP-5029	0	53:00:00	0	22:00	0	0
Z40_TP-5036	2	5:00	0.3	65:00:00	0.9	1.7
Z40_TP-5037	2	5:00	0.3	65:00:00	0.9	1.7
Z40_TP-5040	3.7	6:00	1	25:00:00	1.9	2.8
Z40_TP-5079	4.1	6:00	1.1	51:00:00	2.1	3
Z40_TP-5080	4.5	6:00	1.2	51:00:00	2.3	3.3
Z40_TP-5082	1.4	6:00	0.5	51:00:00	0.8	0.9
Z40_TP-5088	0	6:00	0	1:00	0	0
Z40_TP-5120	4.2	6:00	1.1	51:00:00	2.1	3.1
Z40_TP-5121	3.3	6:00	0.9	51:00:00	1.7	2.4
Z40_TP-5123	0	6:00	0	1:00	0	0
Z40_TP-5200	1.3	67:00:00	0.1	57:00:00	0.8	1.2
Z40_TP-6027	2.3	32:00:00	0.1	50:00:00	1	2.2
Z40_TP-6030	2.6	5:00	0	41:00:00	0.6	2.6
Z40_TP-6034	3.8	29:00:00	0.3	41:00:00	1.1	3.5
Z40_TP-6036	0	6:00	0	1:00	0	0
Z40_TP-6148	1.1	6:00	0.3	49:00:00	0.5	0.8
Z40_TP-62	0.1	6:00	0	1:00	0	0
Z40_TP-81	2.7	6:00	0.9	52:00:00	1.6	1.8
Z40_TP-84	3.6	6:00	1.2	52:00:00	2	2.4
Z40_TP-87	2.3	6:00	0.6	27:00:00	1.2	1.7
Z40_TP-89	0	36:00:00	0	31:00:00	0	0

APPENDIX F

Modeling Results Scenario 5 – Fire Flows

Table F-1. Fire Flow Analysis Results – Phase 1 and Phase 2

PHASE 1 - FIRE FLOW							
ID	Static Demand (gpm)	Static Pressure (psi)	Static Head (ft)	Fire-Flow Demand (gpm)	Residual Pressure (psi)	Residual Head (ft)	Available Flow @Hydrant (gpm)
FLGP-01-2	189	77	224	2,000	76	220	16,779
FLGP-02-3	189	73	224	2,000	72	220	17,271
FLGP-03-2	189	77	224	3,000	74	215	16,915
FLGP-04-1	189	75	224	2,000	73	218	14,899
FLGP-04-2	189	77	224	2,000	75	217	13,136
FLGP-05-1	189	77	224	2,000	70	208	7,410
FLGP-06-3	189	77	224	3,000	73	213	14,544
NTDA-10-3	0	67	226	2,000	65	223	15,278
NVSN-01-1	82	75	224	3,000	71	215	15,980
NVSN-01-2	82	73	224	3,000	69	214	14,771
NVSN-01-4	82	73	224	2,000	72	220	17,580
NVSN-02-1	82	75	224	2,000	74	220	16,525
NVSN-02-2	82	75	224	2,000	74	220	17,132
NVSN-02-3	82	75	224	2,000	73	219	16,131
NVSN-03-1	82	73	224	2,000	71	219	15,450
NVSN-04-2	82	67	226	2,000	66	222	14,356
Z40_TD-5915	0	72	225	3,000	68	218	13,954

PHASE 2 - FIRE FLOW							
ID	Static Demand (gpm)	Static Pressure (psi)	Static Head (ft)	Fire-Flow Demand (gpm)	Residual Pressure (psi)	Residual Head (ft)	Available Flow @Hydrant (gpm)
FLGP-01-1	454	72	214	2,000	68	204	11,847
FLGP-01-2	454	73	214	2,000	71	210	19,901
FLGP-02-1	375	71	214	2,000	66	201	9,431
FLGP-02-3	375	69	215	2,000	68	211	27,933
FLGP-03-2	415	73	214	3,000	71	208	21,469
FLGP-04-1	339	71	214	2,000	70	210	24,318
FLGP-04-2	339	73	214	2,000	71	208	15,825
FLGP-05-1	403	73	215	2,000	71	211	14,693
FLGP-06-1	1,151	69	215	3,000	67	210	29,538
FLGP-06-2	0	67	215	3,000	65	209	18,274
FLGP-06-3	1,151	73	214	3,000	71	208	24,159
FLGP-06-4	0	72	216	3,000	69	210	13,923
NTDA-10-3	0	62	215	2,000	61	212	24,758
NTDA-10-5	0	61	215	2,000	60	212	29,304
NVSN-01-1	103	71	214	3,000	69	210	28,640
NVSN-01-2	103	69	214	3,000	67	209	22,142
NVSN-01-4	103	69	215	2,000	68	211	28,783
NVSN-02-1	159	71	214	2,000	70	211	24,663
NVSN-02-2	159	71	214	2,000	70	211	27,709
NVSN-02-3	159	71	214	2,000	70	211	27,050
NVSN-03-1	268	69	214	2,000	68	211	28,416
VSCP-03-2	409	61	216	2,000	60	213	31,916
Z40_TD-5915	0	67	215	3,000	66	212	33,044

Table F-2. Fire Flow Analysis Results – Phase 3 and Phase 4

PHASE 3 - FIRE FLOW							
ID	Static Demand (gpm)	Static Pressure (psi)	Static Head (ft)	Fire-Flow Demand (gpm)	Residual Pressure (psi)	Residual Head (ft)	Available Flow @Hydrant (gpm)
FLGP-01-1	454	74	218	2,000	67	203	8,194
FLGP-01-2	454	76	220	2,000	74	216	18,019
FLGP-02-1	375	72	217	2,000	61	191	5,807
FLGP-02-3	375	72	221	2,000	71	219	24,426
FLGP-03-2	415	76	220	3,000	74	215	19,567
FLGP-04-1	339	74	220	2,000	72	217	20,875
FLGP-04-2	339	76	220	2,000	74	215	14,707
FLGP-05-1	403	75	220	2,000	72	213	11,561
FLGP-06-1	1,151	72	221	3,000	71	219	26,443
FLGP-06-2	0	70	221	3,000	67	215	15,934
FLGP-06-3	1,151	76	220	3,000	73	214	20,680
FLGP-06-4	0	74	220	3,000	68	208	10,843
NTDA-10-3	0	65	223	2,000	65	222	22,378
NTDA-10-5	0	65	225	2,000	65	225	28,374
NVSN-01-1	103	74	221	3,000	73	218	24,769
NVSN-01-2	103	72	221	3,000	70	217	19,410
NVSN-01-4	103	72	221	2,000	71	220	25,395
NVSN-02-1	159	74	220	2,000	73	218	21,369
NVSN-02-2	159	74	220	2,000	73	218	23,680
NVSN-02-3	159	74	221	2,000	73	218	23,550
NVSN-03-1	268	72	221	2,000	71	219	24,477
NVSN-04-2	257	66	223	2,000	66	222	24,867
VSCP-03-2	409	64	222	2,000	63	221	28,237
Z40_TD-5915	0	71	223	3,000	70	222	30,268

PHASE 4 - FIRE FLOW							
ID	Static Demand (gpm)	Static Pressure (psi)	Static Head (ft)	Fire-Flow Demand (gpm)	Residual Pressure (psi)	Residual Head (ft)	Available Flow @Hydrant (gpm)
FLGP-01-1	551	72	213	2,000	63	193	7,238
FLGP-01-2	551	74	216	2,000	70	207	13,950
FLGP-02-1	503	70	211	2,000	56	179	5,333
FLGP-02-3	503	70	217	2,000	68	211	21,621
FLGP-03-2	448	74	216	3,000	69	204	17,598
FLGP-04-1	551	73	217	2,000	71	214	26,009
FLGP-04-2	551	74	216	2,000	71	209	14,926
FLGP-05-1	538	74	216	2,000	72	213	14,746
FLGP-06-1	971	71	218	3,000	68	211	25,247
FLGP-06-2	971	68	218	3,000	65	210	20,472
FLGP-06-3	971	74	217	3,000	72	210	25,021
FLGP-06-4	971	72	216	3,000	69	209	14,476
NTDA-08-1	462	70	222	3,000	68	217	24,683
NTDA-08-2	462	70	222	3,000	66	213	14,808
NTDA-10-3	281	65	222	2,000	64	220	36,504
NTDA-10-5	281	64	223	2,000	63	221	38,644
NVSN-01-1	168	73	220	3,000	71	214	33,615
NVSN-01-2	168	71	219	3,000	67	210	22,413
NVSN-01-4	168	70	217	2,000	68	211	20,997
NVSN-02-1	258	72	217	2,000	70	211	21,601
NVSN-02-2	258	72	217	2,000	70	212	24,276
NVSN-02-3	258	73	219	2,000	71	214	28,363
NVSN-03-1	436	71	219	2,000	69	215	31,158
NVSN-04-2	639	66	222	2,000	65	220	36,259
VSCP-03-2	509	64	223	2,000	63	221	40,690
Z40_TD-5915	0	70	223	3,000	69	220	41,849